

# Robust Predictive Feedback Control for Constrained Systems

Leonardo Giovanini and Michael Grimbale

**Abstract:** A new method for the design of predictive controllers for SISO systems is presented. The proposed technique allows uncertainties and constraints to be concluded in the design of the control law. The goal is to design, at each sample instant, a predictive feedback control law that minimizes a performance measure and guarantees of constraints are satisfied for a set of models that describes the system to be controlled. The predictive controller consists of a finite horizon parametric-optimization problem with an additional constraint over the manipulated variable behavior. This is an end-constraint based approach that ensures the exponential stability of the closed-loop system. The inclusion of this additional constraint, in the on-line optimization algorithm, enables robust stability properties to be demonstrated for the closed-loop system. This is the case even though constraints and disturbances are present. Finally, simulation results are presented using a nonlinear continuous stirred tank reactor model.

**Keywords:** Predictive control, parametric optimization, multi-objective optimization.

---

## 1. INTRODUCTION

Over the last few decades *model predictive control* (MPC) has been applied successfully in many applications. MPC consists of a step-by-step optimization technique: at each sample a new value of the control signal is calculated on the basis of the current measurement and the prediction of the future states and outputs (see e.g. [9]). The predictive control technique is very popular since it is possible to handle constraints on the input and output signals. The design of the control law is usually based on two assumptions: *a*) there is no uncertainty and *b*) the disturbance, which includes the effect of uncertainties, has a well defined behavior (the most common assumption is that the disturbance remains constant over the prediction horizon). The resulting control law will therefore be optimal for the nominal plant model and the disturbance model assumed during the design. Thus, the closed-loop performance may be rather poor and constraints may be violated, when there are uncertainties and/or disturbances in the system.

Various modifications of MPC algorithms have been proposed to ensure stability in the presence of modelling errors; these changes can be grouped into four general categories:

- **Detune the controller by suppressing input movement:** this method is motivated by the fact that one can always stabilize an open-loop stable system by making the controller less aggressive; in the limit of a completely passive controller, the system reverts to its stable open-loop behaviour. Methods based on detuning the controller share two fundamental limitations; appropriate tuning factors must be computed or determined from closed-loop simulation and the closed-loop performance may suffer unnecessarily when the model is accurate [10,18,27,28].

- **Minimize the worst-case controller cost:** is one of the most heavily studied robust stability methods. Lee and Yu [19] summarize the development of so-called *min max* algorithms, pointing out that the usual open-loop implementation may perform poorly. They propose a closed-loop approach that is capable of better performance, and discuss computationally tractable approximations. The main disadvantage of the *min max* approach is that control performance may be too conservative in some cases [2,5,19,24].

- **Cost function constraints:** this approach to the robust stability problem involves that the use of cost function constraints and leads to robust stability for a finite set of stable subject to hard input and soft state constraints [3]. Robust stability is achieved by adding cost function constraints that prevent the sequence of optimal controller costs from increasing for the true plant. The optimal input is re-computed at each time step by solving a convex semi-infinite program. The solution is Lipschitz continuous in the state at the origin; as a result the closed loop system is exponentially stable and asymptotically decaying disturbances can be rejected.

---

Manuscript received November 13, 2003; revised October 16, 2004; accepted October 26, 2004. Recommended by Editorial Board member Young Il Lee under the direction of Editor-in-Chief Myung Jin Chung. This work was supported by the Engineering and Physical Science Research Council grant GR/R04683/01.

Leonardo Giovanini and Michael Grimbale are with the Industrial Control Centre, University of Strathclyde, Graham Hills Building, 50 George Street, Glasgow G1 1QE, UK (e-mails: {leonardo.giovanini, m.grimbale}@eee.strath.ac.uk).

• **State contraction or terminal state constraints:** this approach to the robust stability problem involves adding a constraint that forces all possible system states to contract on a finite horizon, or to terminate in a robustly stabilizable region. If the horizon is short, state contraction constraints may have feasibility problems or may be so conservative that they cause an unacceptable performance loss [15,17,29].

A significant disadvantage of most robust control algorithms is that all possible plant dynamics are considered to be equally likely; thus the controller focuses necessarily on the worst-case performance at each time step. However, typical statistical assumptions for a process identification experiment lead to an estimate of the joint probability distribution function for the plant parameters, providing a clear indication of which parameter set is most likely to be encountered by the controller. The typical *min max* controller does not exploit this knowledge and it may spend most of its time focused on plant dynamics that are extremely unlikely to occur.

The main contribution of this paper is a predictive controller that combines a direct feedback action with a multi-objective optimization of the control law, which is performed at each sample. The stability of the closed-loop system is guaranteed using an inequality end constraint in the control variable, called a *contractive constraint*. Moreover, contrary to the end constraint proposed by other authors [21,20], neither the region of attraction nor the control law need be pre-computed.

The organization of the paper is as follow: Firstly, in Section 2 the basic mathematical problem formulation is presented and the meaning of the design parameters is discussed. At the end of this section, the effect of the contractive constraint over closed-loop response is analyzed. Then, in Section 3 the basic problem formulation is extended using polytopic ideas, to cope with slowly time-varying or nonlinear systems. The objective function of the new optimization problem is analyzed and compared with the objective function employed in the specialist literature. In Section 4 we show the results obtained from the application of the proposed algorithm to a nonlinear continuous stirred tank reactor. Finally, the conclusions are presented in Section 5.

## 2. PREDICTIVE FEEDBACK CONTROL

Model predictive control refers to the class of algorithms that use a model of the system to predict the future behavior of the controlled system and to then compute the control action such that a measure of the closed-loop performance is minimized and constraints are satisfied (Fig. 1(a)). Predictions are handled according to the so called receding horizon control philosophy: a sequence of future control

actions is chosen, by predicting the future evolution of the system and the control at time  $k$  is applied to the plant until new measurements are available. Then, a new sequence of future controls is evaluated so as to replace the previous one [9]. A simple MPC formulation can be expressed in the following optimization problem:

$$\begin{aligned} \min_{\Delta u(j,k) \quad j=0,1,\dots,U-1} & \sum_{i=1}^V w_y \hat{e}(i,k)^2 + \sum_{i=0}^{U-1} w_u \Delta u(i,k)^2 \\ \text{s.t.} & \\ \hat{y}(i,k) &= y(k) + P(i, z^{-1}) + \sum_{j=0}^i \tilde{h}_j \Delta u(i-j,k) \quad i \in [1, V] \end{aligned} \tag{1}$$

where  $\hat{y}(i,k)$  is the closed-loop prediction error at time  $k+i$  based on measurement until time  $k$ . This includes the effect of past control actions, through the open-loop predictor  $P(i, z^{-1})$ , and the effect of future control actions determined by the impulse model coefficients  $\tilde{h}_j$ . The prediction  $\hat{y}(i,k)$  is updated using the current measurement  $y(k)$ . The transfer function of the corrected open-loop predictor  $P(i, z^{-1})$  is given by (see Appendix A)

$$P(i, z^{-1}) = \tilde{a}_i z^{-1} + \sum_{j=i+1}^N \tilde{h}_j z^{i-j} + \sum_{j=1}^N \tilde{h}_j z^{-j}, \tag{2}$$

where  $N$  is the convolution length,  $\tilde{a}_i \quad i=1,2,\dots,N$  is the coefficient of the step response and  $\tilde{h}_j \quad j=1,2,\dots,N$  is the coefficient of the impulse response. The prediction horizon  $V$  and control horizon  $U \leq V$ , along with the output weighting matrix  $w_y$  and the input weighting matrix  $w_u$  are the user specified tuning parameters.

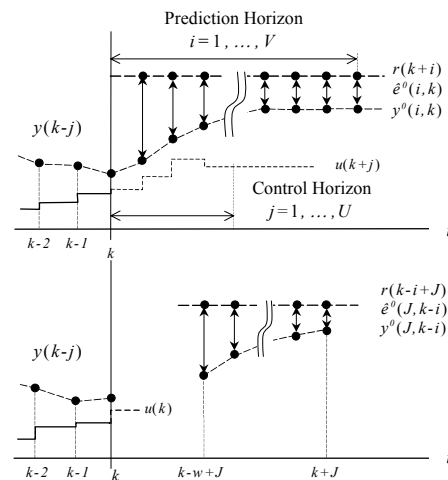

Fig. 1. MPC and Predictive feedback set ups.

As many authors have shown (see i.e. [19]), this formulation of the problem implies a control philosophy similar to an optimal open-loop control law, which allows constraints to be included in a simple and efficient way. In this framework, the stability and robustness problems have been addressed employing a worst-case minimization of the predicted error over a set of model realizations that describe the plant [11]. To guarantee constraint fulfillment for every possible model realization, it is clear that the control actions have to be chosen to be safe enough to cope with the worst case model realization [12]. This effect is evaluated by predicting the open-loop evolution of the system driven by a worst-case model. As investigated by Lee and Yu [19], this inevitably leads to over conservative control schemes that provide a robust and cautious control. To solve this problem, the authors suggest the exploitation of control movements to mitigate the effects of uncertainties and disturbances on the closed-loop performance. This is achieved by using the closed-loop prediction and solving a rigorous min-max optimization problem, which is computationally demanding. To overcome the computational burden problem, Bemporad [4] developed a predictive control scheme that also uses the closed-loop predictive action, but it is limited to include a constant feedback gain matrix.

Following the idea proposed by Bemporad [4], Giovanini [14] introduced direct feedback action into the predictive controller. The resulting controller, called *predictive feedback*, uses only one prediction of the process output  $J$  time intervals ahead and a filter, such that the control changes can be computed employing the last  $w$  predicted errors (see Fig. 1(b)). Thus, the predictive control law is given by:

$$u(k) = \sum_{j=0}^v q_j \hat{e}^0(J, k-j) + u(k), \quad (3)$$

where  $q_j, j=0, 1, \dots, v$  are the controller's parameters and  $\hat{e}^0(J, k-j)$  is the open-loop predicted error  $J$  step ahead based on measurements until time  $k-j$

$$\hat{e}^0(J, k-j) = e(k-j) - P(J, z^{-1})u(k-j),$$

where  $e(k-j)$  is the measured error at time  $k-j$ . In this work, [14] it was shown that

- The predictive feedback controller (3) provides better performance than the predictive controller (1), particularly for disturbance rejection, because it employees more feedback information than the standard MPC in the computation of the control law<sup>1</sup>, and
- the parameters of the controller,  $q_j, j=0, 1, \dots, v$ , and the prediction time,  $J$ , can be chosen independently.

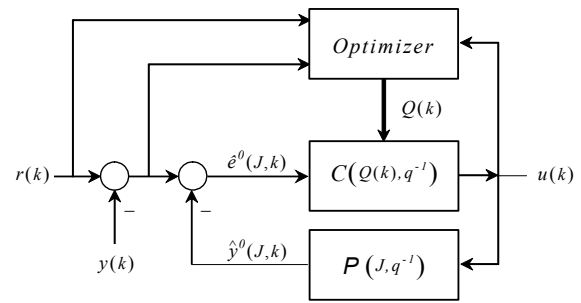

Fig. 2. Structure of the predictive feedback controller.

The last fact is quite important because it makes the tuning procedure easier. The stability criteria derived in the original paper [14] is employed to choose  $J$  and to then tune the filter using any technique. In this framework, the problem of handling the system's constraints was solved tuning the parameters of the controller. This solution is not efficient because it is only valid for the operational conditions considered at the time of tuning the controller [1,13]. Thus, any change in the operational conditions leads to a loss of optimality and to violation of constraints.

The only way to guarantee that the constraints are satisfied is to optimize the control law (3) for every change, in reference or disturbance that is happening in the system. Following this idea, the original predictive feedback controller is modified by including an optimization problem into the controller such that the parameters of the controller are recomputed at each sample instant. The structure of the resulting controller is shown in Fig. 2.

**Remark 1:** The actual control action  $u(k)$ , is computed using the past predicted errors and control movements, whereas the vector of parameters  $-Q(k)$  is optimized over the future closed-loop system behavior. Thus, the resulting control law minimizes the performance measure and guarantees the fulfillment of all the constraints over the whole prediction horizon.

Before introducing the optimization problem the predictive control law (3) is modified to improve the overall closed-loop performance, in two ways. Firstly, new parameters that weight the past control actions are introduced

$$u(k) = \sum_{j=0}^v q_j \hat{e}^0(J, k-j) + \sum_{j=1}^w q_{j+v} u(k-j). \quad (4)$$

This fact allows the closed-loop performance to be improved. However the decoupling property between the prediction time  $J$  and the parameters of the

<sup>1</sup> In the traditional formulations of MPC, the algorithms only employ the last measurement, while the predictive feedback employs the last  $v$  measurements.

controller  $q_j$   $j=0,1,\dots,v+w$  is lost for most situations. This result is summarized in the following theorem.

**Theorem 1:** Given a system controlled by a predictive feedback controller (4), the closed-loop system will be robustly stable if and only if

$$\frac{1 - \sum_{j=1}^w |q_{j+v}|}{\sum_{j=0}^v |q_j|} + \tilde{a}_J > \sum_{i=J+1}^N |\tilde{h}_i| + \sum_{i=1}^N |h_i - \tilde{h}_i| + \sum_{i=N+1}^{\infty} |h_i|. \quad (5)$$

**Proof:** See Appendix B.  $\square$

After augmenting the controller, it is allowed to vary in time

$$u(k) = \sum_{j=0}^v q_j(k) \hat{e}^0(J, k-j) + \sum_{j=1}^w q_{j+v}(k) u(k-j), \quad (6)$$

this fact gives enough degrees of freedom to handle the constraints present in the system. It is well known that the optimal result is obtained when the control law is time-varying. However, as many authors have pointed out, only few control steps have a strong effect on the closed-loop performance (see i.e. [22]). The control law is therefore modified so that the control law is assumed time-varying for the first  $U$  samples and it is time invariant for the remaining ones

$$u(k+i) = \sum_{j=0}^v q_j(k+i) \hat{e}^0(J, k+i-j) \quad 0 \leq i < U, \quad (7a)$$

$$+ \sum_{j=1}^w q_{j+v}(k+i) u(k+i-j)$$

$$u(k+i) = \sum_{j=0}^v q_j(k+U) \hat{e}^0(J, k+i-j) \quad \forall i \geq U. \quad (7b)$$

$$+ \sum_{j=1}^w q_{j+v}(k+U) u(k+i-j)$$

Under this design condition, in each sample a set of parameters  $q_j(k+i)$   $j=0,1,\dots,v+w$ ,  $i=0,1,\dots,U$  is computed so that the future closed-loop response will

fulfill the constraints and be optimal. Then, only the first elements of the solution vector  $-q_j(k)$   $j=0,1,\dots,v+w$  is applied and the remaining ones  $-q_j(k+i)$   $j=0,1,\dots,v+w$ ,  $i=1,2,\dots,U$  are used as initial conditions for the next sample. The optimization is repeated until a criterion, applied over the error and/or manipulated variable, is satisfied. When the stopping criterion is fulfilled the last element  $-q_j(k+U)$   $j=0,1,\dots,v+w$ ,  $i=1,2,\dots,U$  is applied and the optimization is stopped. This criterion is usually selected such that the change in the control law can be produced without a significant change in the closed-loop response.

In order to obtain a stabilizing control *i*) the control law (7) must be feasible everywhere, and *ii*) the control law (7) must lead to an output admissible set, called  $\Xi$ . In others word, we wish  $\Xi$  to be a *positively invariant* set [11]. In the next section the optimization problem employed to compute the parameters of the controller will be introduced. It includes an end constraint over the control action, called *contractive constraint*, which guarantees the closed-loop stability and accelerates numerical convergence by selecting feasible solutions with bounded input/output trajectories.

## 2.1. The optimization problem

In the predictive feedback controller (7) the numerator and denominator orders ( $v$  and  $w$ ), the prediction time ( $J$ ) and parameters of the controller ( $q_j$   $j=0,1,\dots,v+w$ ) are the parameters to be optimized. The optimization problem employed to redesign the controller is therefore formulated in the space of the controller's parameter and it is a *mixed-integer and nonlinear problem*. This type of optimization problem is very expensive from a computational point of view, so it was changed into a nonlinear one by fixing the  $v$ ,  $w$  and  $J$ . The prediction time is chosen using the stability criterion (5) and the orders of the controller ( $v$  and  $w$ ) are fixed arbitrarily.

Fixing the integer parameters of the controller ( $v$ ,  $w$  and  $J$ ), the controller parameters can be found by solving the following optimization problem:

$$\min_{q_j \ j=0,1,\dots,v+w} f(r(k+i), y(i,k), u(i,k)) \quad (8a)$$

st.

$$\hat{y}^0(J, k+i) = y(k) + P(J, q^{-1})u(i,k) \quad i \in [0, V], \quad (8b)$$

$$\hat{y}(i,k) = y(k) + P(J, q^{-1})u(k) + \sum_{j=0}^i \tilde{h}_j u(k+j) \quad (8c)$$

$$u(i,k) = \sum_{j=0}^v q_j(k+i) \hat{e}^0(J, k+i-j) + \sum_{j=1}^w q_{j+v}(k+i) u(k+i-j) \quad i \in [0, U-1], \quad (8d)$$

$$u(i,k) = \sum_{j=0}^v q_j(k+U) \hat{e}^0(J, k+i-j) + \sum_{j=1}^w q_{j+v}(k+U) u(k+i-j) \quad i \in [U, V], \quad (8f)$$

$$|\Delta u(V, k)| \leq \varepsilon,$$

where  $V$  is the overall number of sample instants considered. The objective function (8a) measures the future closed-loop performance of the system. The first constraint, (8b), is the  $J$  step ahead open-loop prediction  $\hat{y}^0(J, k+i)$ , which is employed to compute the control action  $u(i, k)$ . It is calculated from all the information available until time  $k+i$ . (8c) is the closed-loop prediction  $\hat{y}(i, k)$ , which is used to compute the future performance of the system, to evaluate the constraints and to compute  $\hat{y}^0(J, k+i)$ . It is computed from all the information available at time  $k+i$ . The third and fourth equations are the control law (7). Finally, an additional constraint, called *contractive constraint*, is included in this formulation through the last equation. This constraint deserves specific explanation in the next subsection.

The optimization problem formulated above performs a sort of closed-loop simulation each time the optimization problem (8) tries new parameter values and therefore, the closed-loop time-domain response, as well as the evolution of internal variables, may be evaluated directly. The key element of this optimization problem is to find a control law that satisfies all the constraints. This reduces the computational burden in the minimization of the performance measure. In control scenarios, it is natural that inputs and outputs have limits. The particular numerical issues discussed in this paper are the same whether such constraints are included or not.

During the design of the control law the constraints are met before finding the minimum of the objective function. The opposite case implies there is no feasible solution. Then, the optimization may be stopped once the design conditions are satisfied. This fact does not mean reducing the importance of the global minimum; it simply provides a practical criterion for stopping the optimization.

## 2.2. Final control condition

The contractive constraint (8f) asks for null or negligible control movement at the end of the control horizon. It is equivalent to requiring that both  $y$  and  $u$  remain constant after the time instant  $k+V$ . Therefore, it ensures the internal stability of all systems that are open-loop stable, even those having zeros in the right half plane. These results are summarized in the following theorem.

**Theorem 2:** Given a closed-loop system that satisfies  $|\Delta u(V, k)| \leq \varepsilon \quad \forall \varepsilon \geq 0$ , the closed-loop system is exponentially stable.

**Proof:** See Appendix C.  $\square$

When  $\varepsilon=0$ , the constraint (8f) is very restrictive from a computational point of view. However, it possesses a very important property: it is not necessary to reach the global minimum to maintain stability. It only needs that a reduction in the objective function takes place at each step, since the objective

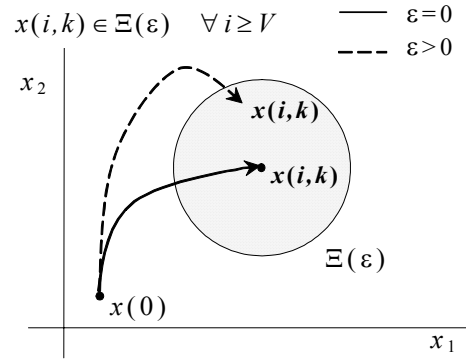

Fig. 3. Behavior of the system's states with  $\varepsilon$ .

function acts like a Lyapunov function of the closed-loop system and the resulting control law will be deadbeat [16].

When  $\varepsilon > 0$ , for the system output  $y$  verify

$$|r(k+i) - \hat{y}(i, k)| \leq \varepsilon Gp(0) \quad \forall i \geq V,$$

which means that  $y$  stays in a manifold of radius  $\varepsilon Gp(0)$  around the setpoint starting from  $k+V$  (Fig. 3). This constraint may also be used as a design condition affecting the closed-loop performance. Defining the value of  $V$  is an alternative way for determining the closed-loop settling time. Let us observe that if  $V$  is large enough (larger than the system's dynamics) and  $\varepsilon > 0$ , this constraint will not affect the closed-loop performance and the closed-loop response will be shaped by the objective function and any other constraints.

From a numerical point of view, the constraint (8f) helps to select feasible solutions with bounded input / output trajectories. It therefore accelerates the numerical convergence and it avoids oscillations and ripples between sampling points. This is a problem frequently arising from discrete cancellation controllers, particularly when applied to high-order systems.

The results described in this section can be extended to other type of setpoint following the procedure employed in Appendix C. For example if we want to follow a ramp setpoint, the closed-loop system will be exponentially stable if

$$|\Delta \Delta u(V, k)| \leq \varepsilon, \quad (9)$$

where  $\Delta \Delta$  is the second difference operator.

**Example 1:** Consider the following linear model

$$Gp(s) = \frac{-0.001s + 0.0192}{s^2 + 0.6124s + 4.78755} e^{-0.5s},$$

which results from the linearization of the CSTR

reactor previously employed by Morningred et al. [23] (equation (51)) at nominal parameters and  $q_C(t) = 110 \text{ lt min}^{-1}$ . This nonlinear model was previously employed by Morningred et al. [23] to test nonlinear predictive control algorithms. The discrete transfer function is obtained by assuming a zero-order hold in the input and a sampling time  $t_S = 0.1 \text{ sec}$  and the convolution length  $N$  was fixed in 200 terms. The manipulated control should satisfy the following restrictions

$$u(k) \leq 10 \quad \forall k, \quad (10)$$

which arises from the fact that the non-linear system becomes uncontrollable when the absolute value of  $q_C(t)$  exceed  $113 \text{ lt min}^{-1}$ . In addition, the output concentration must satisfy

$$\begin{aligned} y(k) &\leq 1.01r_0 \quad \forall k, \\ |e(k)| &\leq 0.01r_0 \quad \forall k > N_0 + 50, \end{aligned} \quad (11)$$

where  $r_0$  is the reference value and  $N_0$  is the time of change. Finally, a zero-offset steady-state response is demanded for the steady-state controller

$$\sum_{j=1}^w q_{j+v}(U) = 1. \quad (12)$$

The prediction time is chosen using the stability condition (30), so the prediction time must satisfy:

$$10 \leq J \leq 15 \text{ and } J \geq 20. \quad (13)$$

To obtain a good performance the smaller prediction time ( $J=10$ ) was chosen. Finally, the objective function employed in this example is

$$f = \sum_{i=1}^V \left[ e(k+i)^2 + \lambda \Delta u(k+i)^2 \right], \quad (14)$$

where the time span is defined by  $V=100$ . The control

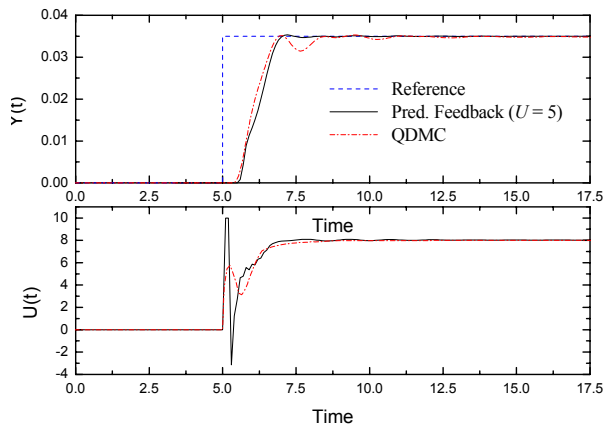

Fig. 4. Comparison of closed-loop responses.

weight  $\lambda$  was fixed at a value such that the control energy has a similar effect to errors in the tuning process ( $\lambda=10^{-3}$ ).

The optimization of the predictive feedback controller may be stopped when

$$\begin{aligned} |e(l)| &\leq 0.05r_0 \quad l = k, k-1, \dots, k-5, \\ |\Delta u(l)| &\leq 0.5. \end{aligned}$$

These conditions imply that there will be no bump when the control law switches to the last controller.

Finally, the remaining parameters of the predictive feedback controller are defined. The orders of the controller's polynomials are arbitrarily adopted such that the resulting controllers include the predictive version of the popular  $PI$  controller ( $v=1$  and  $w=2$ ) and  $U$  was set equal to 5. Both predictive controllers, the *predictive feedback* and QDMC, were implemented using several programs developed in Matlab. The codes were not optimized for efficient implementation. The software routines employ a sequential quadratic algorithm for solving constrained optimization problems.

In Fig. 4 the responses obtained by the predictive feedback controller and a QDMC controller

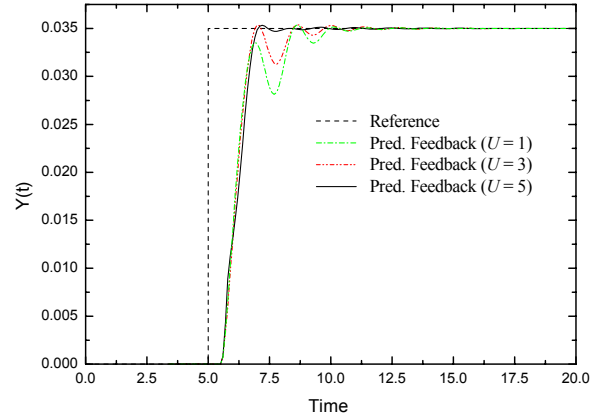

Fig. 5. Closed-loop responses for different  $U$ .

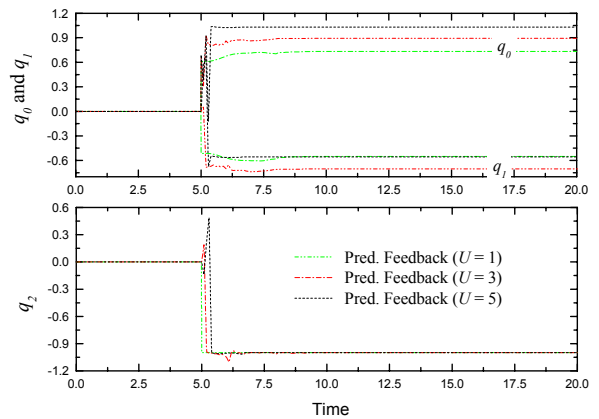

Fig. 6. Evolution of the controller's parameters.

Table 1. Closed-Loop Performance.

Controller	Parameters	IAE
QDMC	$N=200, V=100, U=7, \lambda=10^{-4}$	0.47571
PF <sub>1</sub>	$w=2, v=1, U=1$	0.49200
PF <sub>2</sub>	$w=2, v=1, U=2$	0.45813
PF <sub>3</sub>	$w=2, v=1, U=3$	0.43991
PF <sub>4</sub>	$w=2, v=1, U=4$	0.43351

(equivalent to a full state feedback MPC controller with an integral action) are shown. It shows that the predictive feedback controller satisfies all constraints and obtains a better performance than the QDMC. The predictive feedback controllers exploit the constraints on the manipulated variables to satisfy the constraints on the output response, providing more aggressive control actions than the QDMC (see Fig. 4(b)). This fact is obtained by modifying the parameters of the predictive feedback controllers along the time plot (see Fig. 6). This implies that the closed-loop poles and zeros varying with the time. The integral action ( $q_2=-1$ ) is only applied when the stopping criterion is satisfied, except for the predictive feedback with only one gain ( $U=1$ ). In this case the closed-loop system always has a pole at  $z=-1$ , but the others change their positions until the output satisfies the stopping criterion.

Fig. 4(b) shows that only few initial control movements have strong effect over the closed-loop performance. The same behavior is provided by the QDMC, but the control action is less aggressive than one provided by the predictive feedback due to the presence of the integral action in the control law which reduces the degrees of freedom to shape the closed-loop response.

When the predictive feedback controller has more degrees of freedom (a greater  $U$ ), the controller obtains a better performance (Fig. 5) through more aggressive initial movements and exploiting the constraint (10) for a few samples. These facts are displayed in the behavior of the controller parameters (Fig. 6) that show significant changes in the first

$$\min_{q_j, j=0,1,\dots,v+w} F(r(k+i), y_l(i,k), u_l(i,k)) \quad (15a)$$

st.

$$\hat{y}_l^0(J, k+i) = y_l(k) + P(J, q^{-1})u(i, k) \quad i \in [0, V], \quad (15b)$$

$$\hat{y}_l(i, k) = y(k) + P_l(J, q^{-1})u(k) + \sum_{j=0}^i \tilde{h}_{jl} u_l(k+j) \quad l \in [1, M], \quad (15c)$$

$$u(i, k) = \sum_{j=0}^v q_j(k+i) \hat{e}_l^0(J, k+i-j) + \sum_{j=1}^w q_{j+v}(k+i) u_l(k+i-j) \quad i \in [0, U-1] \quad (15d)$$

$$u(i, k) = \sum_{j=0}^v q_j(k+U) \hat{e}_l^0(J, k+i-j) + \sum_{j=1}^w q_{j+v}(k+U) u_l(k+i-j) \quad i \in [U, V] \quad (15e)$$

$$|\Delta u_l(V, k)| \leq \varepsilon \quad (15f)$$

samples and then they remain constant. The less the degrees of freedom (smaller  $U$ ) the parameters  $q_0$  and  $q_1$  show more movements while  $q_2$  converges faster to  $-1$  (see Fig. 6).

Table 1 summarizes the results obtained in the simulations for the different predictive controllers. It is easy to see to the effect of the number of computed gains. Note the effect of allowing the control law to vary implies an improvement of 10 % compare with the QDMC. When the number of gains employed by the controller is increased, a better performance is obtained, however the performance improvement becomes marginal for  $U$  greater than 5.

### 3. ROBUST PREDICTIVE FEEDBACK CONTROL

In most control problems the model-mismatch problem exists, and it is certainly present any time the process has a nonlinear characteristic and a linear approximation is used. A simple way to capture a moderate non linearity is to use a set of  $M$  models, denoted  $\mathcal{W}$ , in the neighborhood of the nominal operating point. Thus include model uncertainty in the basic formulation of the previous section, for the case in which the process system is not linear. Suppose the uncertainty set  $\mathcal{W}$  is defined by a polytope made of a set of convolution models. The optimization problem may then be written as follows:

See (15a)-15(f)

where  $l \in [1, M]$  stands for a vertex model and  $M$  is the number of models being considered and  $P(J, z^{-1})$  is the transfer function of the *open-loop* predictor (2) for the nominal model. The objective function  $F(\cdot)$  (15a) represents a measure of the future closed-loop performance of the system. It considers all the models are used to represent the controlled system, and deserves specific comments in the next subsection.

**Remark 2:** When  $U=1$  and the performance is measure through an  $l_\infty$  norm

$$f(\cdot) = \max_{l=1,\dots,M} \{\hat{e}_l(i, k) \quad i = 0, \dots, V\},$$

and the optimization problem (15) is equivalent to the predictive controller proposed by Kothare et al. [15].

The problem (15) consists in a set of the original restrictions (8) for each model of  $\mathcal{W}$ , with the control actions  $u(k-j)$   $j=1,2,\dots,w$  and past errors  $e(k-j)$   $j=0,1,\dots,v$  as the common initial conditions and the controller parameters as the common independent variables to optimize. The optimization problem readjusts the controller until all the design conditions are satisfied simultaneously, by a numerical search through a sequence of dynamic simulations. The resulting controller ensures the stability of the closed-loop and gives the best possible performance, satisfying all the models of  $\mathcal{W}$ . This is equivalent to saying that the resulting controller provides robust performance to the closed-loop system. Additionally, this formulation doesn't impose any restriction over the models to ensure closed-loop stability [10,29].

Since all of the models of  $\mathcal{W}$  satisfy the stability condition, the resulting control law guarantees the stability of the original nonlinear system, and it could be used as the predictor  $\hat{P}(J, z^{-1})$  of the control law (7).

### 3.1. The objective function

Since the polytope that must be shaped along the prediction horizon  $V$ , the objective function of the problem (15) should consider all the linear models in simultaneous form. At this point, there is no clear information about which model is the appropriate one to represent the system. A simple way of solving this problem is using a general index of the form

$$F(\cdot) = \sum_{l=1}^M \gamma_l f_l(\cdot), \quad (16)$$

where  $\gamma_l \geq 0$  are arbitrary weights and  $f_l(\cdot)$  is the performance index for model  $l$  measured by any weighting norm

$$f_l(\cdot) = \|\hat{e}(i, k)\|_W^p + \|u(i, k)\|_R^p \quad i = 0, \dots, V, 1 \leq p \leq \infty.$$

Notice that the coefficients  $\gamma_l$  allow us to assign a different weight to each index corresponding to model  $l$ , in such a way that emphasizes, or not, the influence of a certain model in the control law.

In general, the solution obtained by the problem (15) produces a decrease in some of the components of  $F$ , say  $f_l$   $l \in [1, M]$ , and the increase of the remaining,  $f_m$   $m \neq n \in [1, M]$ . Thus, the minimization of the general index  $f$  depends on the effect of each one of the component  $f_l$  over the index  $F$ . Therefore, the best solution doesn't necessarily match with some of the optimal singular values  $f_l$   $l \in [1, M]$ . It is necessarily a trade off solution amongst the different components of the general index  $F$ .

This type of optimization problem is described naturally as a *multi-objective optimization problem*.

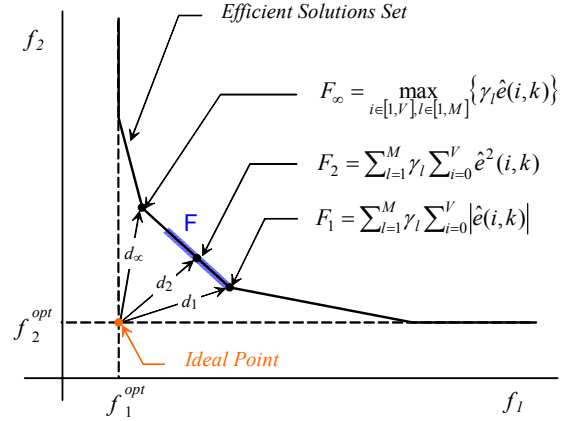

Fig. 7. Solutions sets of the optimization problem (15) for several performance measures.

Several surveys on the concept and methodology employed in multi-objective optimization have been given by Chankong and Haimes [6], Gal [8] and Sawaragi et al. [25]. In this paper we only recall some definitions to explain the properties of the proposed formulation. The central idea in the multi-objective optimization is the concept of *noninferior solution*, which refers to the best possible solution achievable for the original problem. A formal definition of the efficient solution was given by Chankong and Haimes [6], is:

**Definition 1:**  $q^*$  is said to be an *noninferior solution* of the optimization problem if there exists no other feasible solution  $q$  such that  $f_j(q) \leq f_j(q^*) \forall j=1,2,\dots,M$ , where the inequality is strict for at least one  $j$ . Then, the efficient solution set  $F$  is given by

$$F = \left\{ q \in Q \mid q : f_j(q) \leq f_j(q^*) \quad \forall j = 1, \dots, M \right\},$$

where  $Q$  is the solution space.

The problem (15) with the objective function (16), corresponds to a *hybrid characterization* of the multi-objective problem [6], where the performance is measured through a weighted-norm objective function (equation (16)) and the design constraints are considered through the additional restrictions. In this framework, the performance index (16) can be seen as the distance between the ideal solution, which results from the minimum of each component, and the real solution (Fig. 7). Thus, the solutions provided by the problem (15) will minimize the distance between the ideal and the feasible solutions, approaching them as closely as the design constraints and the system dynamics will allow.

**Remark 3:** If only one of the weights is not null, said  $\gamma_l$   $l \in [1, M]$ , the resulting control law will achieve the best possible performance for the selected model and guarantee the closed-loop stability for the



remaining models.

In this case, the closed-loop performance achieved by the model  $l$  will be constrained by stability requirements of the remaining models. Therefore, it is possible that the performance obtained by the model  $l$  differs from the optimal singular value.

This formulation of the optimization problem enjoys an interesting property that is summarized in the following theorem:

**Theorem 3:** Given the optimization problem (15) with the objective function (16), the norm employed to measure the performance is different to the worst case ( $p \neq \infty$ ) and  $\gamma_l > 0$   $l=1, \dots, M$ , then any feasible solution is at least a local non-inferior solution.

**Proof:** See Theorems 4.14, 4.15 and 4.16 of Chankong and Aimes [6].  $\square$

The main implication of this theorem is the fact that any feasible solution provided by the problem (15) with the objective function (16) will be the best possible and it will provide an equal or a better closed-loop performance than the worst case formulations of predictive controllers [15,29].

**Example 2:** Now, consider the following set of discrete-time linear models

$$Gp_1(z) = \frac{0.2156 \cdot 10^{-3} z^{-5}}{z^2 - 1.7272z + 0.7793},$$

$$Gp_2(z) = \frac{0.1153 \cdot 10^{-3} z^{-5}}{z^2 - 1.7104z + 0.7547},$$

$$Gp_3(z) = \frac{0.1153 \cdot 10^{-3} z^{-5}}{z^2 - 1.7104z + 0.7547},$$

which represent the nonlinear model (49) in the operating region

$$90 \leq q_C \leq 100,$$

for nominal parameters. In this case, there is no manipulated constraint, but the output concentration must satisfy

$$\begin{aligned} y(k) &\leq 1.02r_0 \quad \forall k, \\ |e(k)| &\leq 0.02r_0 \quad \forall k > N_0 + 50, \end{aligned} \quad (17)$$

where  $r_0$  is the reference value and  $N_0$  is the time of change. Finally, a zero-offset steady-state response is demanded for the steady-state controller

$$\sum_{j=1}^w q_{j+v}(U) = 1. \quad (18)$$

Now, define the parameters of the predictive feedback controller. The orders of the controller's polynomials are arbitrarily adopted such that the closed-loop poles can be arbitrary placed ( $v=2$  and  $w=3$ ). The prediction time  $J$  is chosen such that it guarantees the closed-loop stability of the three models

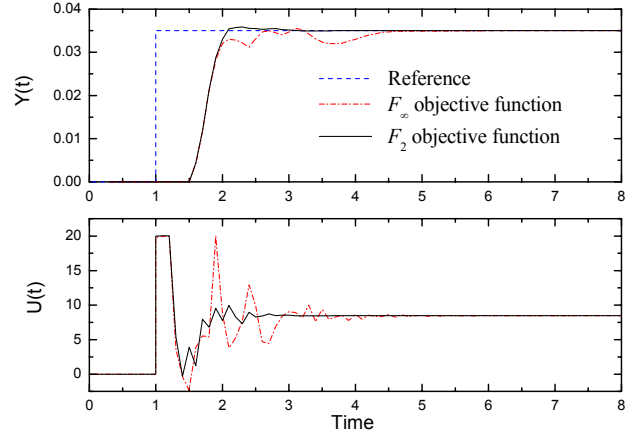

Fig. 8. Closed-loop responses for different objective functions.

simultaneously [14]

$$J = \max(J_1, J_2, J_3) = 8, \quad (19)$$

where  $J_l=1$   $l=1,2,3$  is the minimum prediction time that satisfies (30) for each model. Finally, the number of controllers to compute was fixed at five ( $U=5$ ).

In this example, the effect of different objective functions is evaluated. The most popular performance measures will be considered:

$$\begin{aligned} F_2 &= \sum_{l=1}^3 \gamma_l f_l, \\ F_\infty &= \max_{l=1,2,3} (\gamma_l f_l), \end{aligned}$$

where  $f_l$   $l=1,2,3$  is given by (14) with the time span  $V$  equal to 100 and the control weight  $\lambda$  equal to  $10^{-2}$ . Since we found no reason to differentiate between the models, adopt  $\gamma_l=1$   $l=1,2,3$ .

Fig. 8 shows that the responses obtained by the predictive feedback controllers with both objective functions. Both controllers satisfy all constraints but the controller with the objective function  $F_2$  provides a better performance and smoother control than that with  $F_\infty$  objective function. Both controllers have similar initial manipulated movements but after that, the controller with  $F_2$  provides smoother movements than the controller with  $F_\infty$  (Fig. 8(b)).

#### 4. SIMULATION AND RESULTS

Consider the problem of controlling a continuously stirred tank reactor (CSTR) in which an irreversible exothermic reaction is carried out at constant volume (see Appendix D). This is a nonlinear system originally used by Morningred et al. [23] for testing predictive control algorithms. The objective is to control the output concentration  $Ca(t)$  using the coolant flow rate  $q_C(t)$  as the manipulated variable.

Table 2. Vertices of polytopic model.

Operating Conditions	Model
<b>Model 1</b> $q_c = 100, \Delta q_c = 10$	$\frac{0.1859 \cdot 10^{-3} z^{-5}}{z^2 - 1.8935z + 0.9406}$
<b>Model 2</b> $q_c = 110, \Delta q_c = -10$	$\frac{0.2156 \cdot 10^{-3} z^{-5}}{z^2 - 1.7272z + 0.7793}$
<b>Model 3</b> $q_c = 100, \Delta q_c = -10$	$\frac{0.1153 \cdot 10^{-3} z^{-5}}{z^2 - 1.7104z + 0.7547}$
<b>Model 4</b> $q_c = 90, \Delta q_c = 10$	$\frac{0.8305 \cdot 10^{-4} z^{-5}}{z^2 - 1.7922z + 0.8241}$

The inlet coolant temperature  $T_{CO}(t)$  (measurable) and the feed concentration  $Ca_0(t)$  (non-measurable) represent the disturbances. The output concentration has a measured time delay of  $t_d = 0.5 \text{ min}$ .

The nonlinear nature of the system is shown in Fig. 9, where we can see the open-loop response to changes in the manipulated variable. This figure shows the dynamic responses to the following sequence of changes in the manipulated variable  $q_c(t)$ :  $+10 \text{ lt min}^{-1}$ ,  $-10 \text{ lt min}^{-1}$ ,  $-10 \text{ lt min}^{-1}$  and  $+10 \text{ lt min}^{-1}$ . From this figure it is easy to see that the reactor control is quite difficult due to the change in the dynamics from one operational condition to another and the presence of zeros near the imaginary axis. Besides, the CSTR becomes uncontrollable when  $q_c(t)$  go to beyond of  $113 \text{ lt min}^{-1}$ .

Four discrete linear models can be determined from the composition responses shown in Fig. 9 using subspace identification techniques [26]. Notice that those changes imply three different operating points corresponding to the following stationary manipulated flow-rates:  $100 \text{ lt min}^{-1}$ ,  $110 \text{ lt min}^{-1}$ , and  $90 \text{ lt min}^{-1}$ . As in Morningred's work, the sampling time period was fixed at  $0.1 \text{ min}$ , which gives about four sampled-data points in the dominant time constant when the reactor is operating in the high concentration region.

Table 2 shows the four process transfer functions

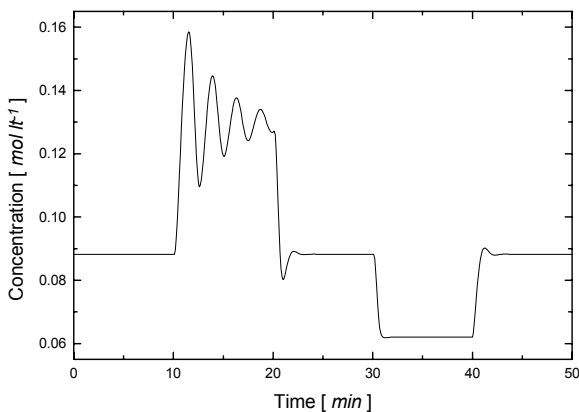

Fig. 9. Open-loop response of the CSTR.

obtained. They define the polytopic models associated with the nonlinear behavior in the operating region being considered. They should be associated to the  $M$  vertex models in the above problem formulation (15). The controller must be able to follow the reference and reject the disturbances present in this system. Thus it is necessary to guarantee its controllability over the whole operational region. Hence, assuming a hard constraint is physically used on the coolant flow rate at  $110 \text{ lt min}^{-1}$ , an additional restriction for the more sensitive model (Model 1 in Table 2) must be considered for the deviation variable  $u(k)$

$$u_1(k) \leq 10 \quad \forall k. \quad (20)$$

and a zero-offset steady-state error

$$\sum_{j=1}^w q_{j+v}(U) = 1. \quad (21)$$

This assumes that the nominal absolute value for the manipulated is around  $100 \text{ lt min}^{-1}$  and the operation is kept inside the polytope whose vertices are defined by the linear models. The constraints (20)-(21) are then included in the optimization problem (15).

Now, define the parameters of the predictive feedback controller. The orders of the controller's polynomials are adopted arbitrarily such that the resulting controllers include the predictive version of popular *PID* controller ( $v=1$  and  $w=2$ ). The open-loop predictor of the controller  $P(J, z^{-1})$  was built using the model 1 (Table 2), because the CSTR is more sensitive in this operating region. The prediction time  $J$  is chosen such that it guarantees the closed-loop stability of the four models simultaneously [14]

$$J = \max(J_1, J_2, J_3, J_4) = 12, \quad (22)$$

where  $J_l$   $l=1,2,3$  and 4 is the minimum prediction time that satisfy (30) for each model. Finally, the number of controllers to compute was fixed at five ( $U=5$ ).

Notice in this case it is the polytope that must be shaped along the time being considered. Hence, the objective function necessary for driving the adjustment must consider all the linear models simultaneously. At a given time instant and operating point, there is no clear information about which model is the most convenient one for representing the process. This is because it depends not only on the operating point but also on the direction the manipulated variable is going to move. The simplest way to solve this problem is using the following objective function

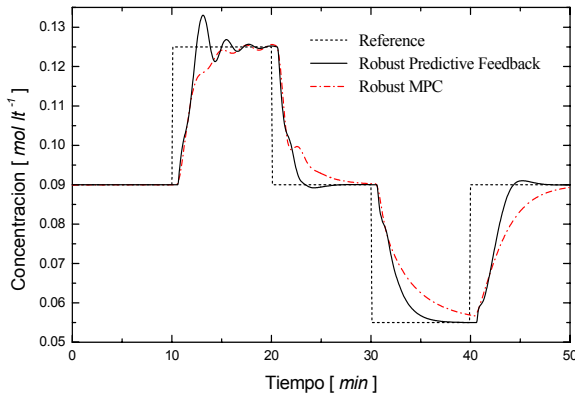

Fig. 10. Closed-loop responses to changes in setpoint.

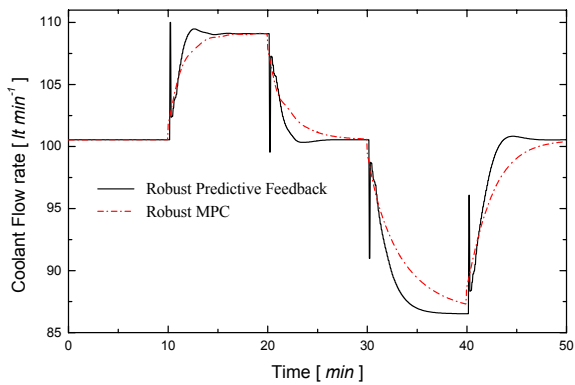

Fig. 11. Manipulated variables corresponding to responses in Fig. 10.

$$F = \sum_{l=1}^M \sum_{i=1}^V \left[ e_l(k+i)^2 + \lambda_l \Delta u_l(k+i)^2 \right], \quad (23)$$

where the time span is defined by  $V=100$  and  $M=4$ . The control weight  $\lambda_l$  was fixed in a value such that the control energy has a similar effect than errors in the tuning process ( $\lambda_l=10^{-3}$ ). Since in this application there is no reason to differentiate between the models, we adopt  $\lambda_l=1 \quad l \in [1, M]$ .

The simulation tests are also similar to Morningred's work and consist of a sequence of step changes in the reference. The set point was changed in intervals of 10 min. from  $0.09 \text{ mol l}^{-1}$  to  $0.125$ , returns to  $0.09$ , then steps to  $0.055$  and returns to  $0.09 \text{ mol l}^{-1}$ .

Fig. 10 shows the results obtained when comparing the predictive feedback controller with the robust MPC developed by Kothare et al. [15]. The superior performance of the predictive feedback controller is due to the objective function employed by each controller. The predictive feedback reveals a poorer performance, with a large overshoot, than the robust MPC to the first change because it is the worst model, but in the remaining ones the predictive feedback provides a better performance. This response

Table 3. Prediction time for each region.

	Model 1	Model 2	Model 3	Model 4
$J$	12	11	10	11

is obtained through a vigorous initial movement in the manipulated variable, which however does not overcome the  $110 \text{ l min}^{-1}$  limit, as shown in Fig. 11.

The prediction time  $J$  can be varied such that a better closed-loop performance in each operational region is obtained. The resulting prediction times are summarized in Table 3. They are the values  $J_l \quad l=1, 2, 3$  and 4 obtained to develop the previous controller. During the operation of the system the predictive horizon  $J$  is adjusted at each sample according to the operating point, which is defined by the final value of the reference.

Fig. 12 shows the results obtained during the simulation. The superior performance of the predictive feedback controller is obtained through a modification of the controller gain [14]. In the two first setpoint changes, the manipulated variable shows a smaller peak than in the previous simulation.

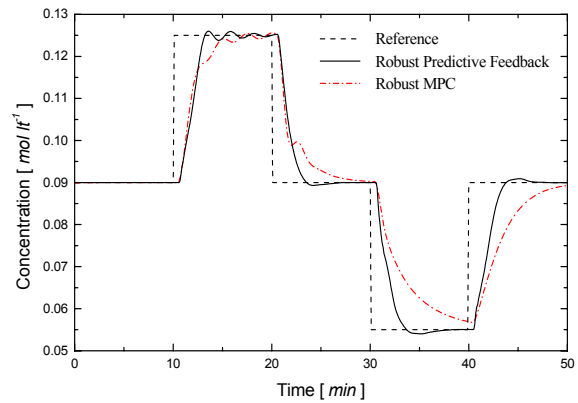
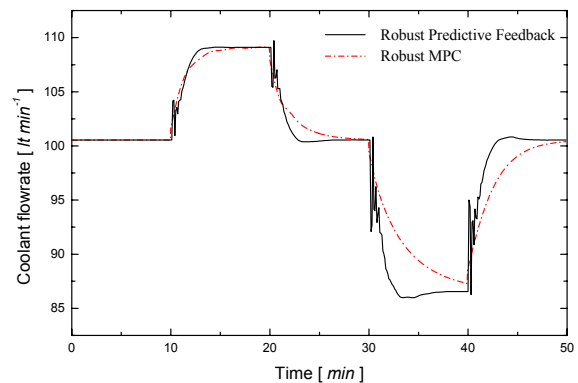

 Fig. 12. Closed-loop responses to changes in setpoint when  $J$  is allowed to vary.

Fig. 13. Manipulated variables corresponding to responses in Fig. 12.

## 5. CONCLUSIONS

A finite horizon predictive feedback scheme was proposed with an end constraint on the control horizon. In this formulation a direct feedback action is included in the optimization that allows the uncertainties and disturbances to be considered in a simple way. The resulting control law is time varying and achieves the robust performance of the system although constraints are present. Furthermore, it has been shown that the addition of the end constraint to the optimal control problem introduces strong stability guarantees, even if there are uncertainties in the system. The results obtained by simulating a linear model and a continuous stirred tank reactor, with important non-linearities, show the effectiveness of the proposed controller. The robustness and performance achieved in the presence of constraints was demonstrated.

### APPENDIX A: OPEN – LOOP PREDICTOR TRANSFER FUNCTION

In many predictive control techniques, the model more frequently used to develop the predictor is the discrete convolution truncated to  $N$  terms [9]. The reason is twofold: *a*) the convolution summation gives the model output explicitly and, *b*) the main impulse response coefficients are relatively easy to obtain. In particular, for *SISO* systems

$$\hat{y}(J, k) = \sum_{i=1}^N \tilde{h}_i u(k + J - i) \quad J < N, \quad (24)$$

which predicts the output value  $J$  sampling intervals ahead,  $k$  represents the current time instant  $t = k t_S$  ( $t_S$  is the sampling interval),  $h_i$   $i = 1, 2, \dots, N$  are the impulse response coefficients and,  $u(k + J - i)$   $i = 1, 2, \dots, N$  is the sequence of inputs to be considered. However, most frequently  $\hat{y}(J, k)$  is not calculated directly from (24) but from a modified expression that includes the prediction for the current time  $\hat{y}(0, k)$ . For this, notice that (24) can also be written as a function of the predicted value for the previous sampling time  $J-1$ ,

$$\hat{y}(J, k) = \hat{y}(J-1, k) + \sum_{i=1}^N \tilde{h}_i \Delta u(k + J - i), \quad (25)$$

where  $\Delta u(k + J - i) = u(k + J - i) - u(k + J - i - 1)$ . Then, successive substitutions of  $\hat{y}(J-1, k)$  by previous predictions gives

$$\hat{y}(J, k) = \hat{y}(0, k) + \sum_{l=1}^J \sum_{i=1}^N \tilde{h}_i \Delta u(k + l - i). \quad (26)$$

This equation defines a  $J$ -step ahead predictor, which includes future control actions

$$\begin{aligned} \hat{y}(J, k) &= \hat{y}(0, k) + \sum_{l=1}^J \sum_{i=1}^N \tilde{h}_i \Delta u(k + l - i) \\ &+ \sum_{l=1}^J \sum_{i=l+1}^N \tilde{h}_i \Delta u(k + l - i). \end{aligned} \quad (27)$$

The future control actions have to be calculated, and therefore they are unknown. To turn the predictor (27) realizable it will be assumed that the control variable will not move in future

$$\Delta u(k + l) = 0 \quad l = 0, 1, \dots, J, \quad (28)$$

then, (26) becomes

$$\hat{y}^0(J, k) = \hat{y}(0, k) + \sum_{l=1}^J \sum_{i=l+1}^N \tilde{h}_i \Delta u(k + l - i), \quad (29)$$

where the upper script  $^0$  recalls the condition (28) is included. It defines a realizable  $J$ -step ahead open-loop predictor in the discrete time domain. The predictor is realizable since only past inputs to the system are used to compute the future behavior. Therefore, the open-loop predictor (29) states the effect of past inputs on the future behavior of the system.

Expanding (29) and taking the  $Z$ -transform results

$$\hat{y}^0(J, z) = \hat{y}(z) + \left[ \sum_{i=2}^N \tilde{h}_i z^{1-i} + \dots + \sum_{i=J+1}^N \tilde{h}_i z^{J-i} \right] (1 - z^{-1}) u(z). \quad (30)$$

Defining the following function

$$H(J, z) = \begin{cases} \sum_{i=l+1}^N \tilde{h}_i z^{J-i} & 0 \leq J < N, \\ 0 & J \geq N, \end{cases} \quad (31)$$

can be written as

$$\hat{y}^0(J, z) = \hat{y}(z) + [H(1, z) + \dots + H(J, z)] (1 - z^{-1}) u(z). \quad (32)$$

Note that there is a recursive relationship

$$H(m, z) = \tilde{h}_{m+1} z^{-1} H(m+1, z) z^{-1}. \quad (33)$$

Then, combining (32) and (33), and rearranging, gives

$$\hat{y}^0(J, z) = \hat{y}(z) + \left[ \sum_{i=2}^N \tilde{h}_i z^{-1} + H(J, z) - H(1, z) z^{-1} \right] u(z).$$

Adding and subtracting  $\tilde{h}_1 z^{-1}$  and operating gives

$$\hat{y}^0(J, z) = \hat{y}(z) + \left[ \tilde{a}_J z^{-1} + H(J, z) \sum_{i=1}^N \tilde{h}_i z^{-i} \right] u(z),$$

where  $\tilde{a}_J$  is the  $J$ th coefficient of step response and  $\sum_{i=1}^N \tilde{h}_i z^{-i}$  the plant model  $\tilde{G}p(z)$ . Hence, the expression (31) can be written

$$\hat{y}^0(J, z) = \hat{y}(z) + \left[ \tilde{a}_J z^{-1} + \sum_{i=J+1}^N \tilde{h}_i z^{J-i} - \sum_{i=1}^N \tilde{h}_i z^{-i} \right] u(z). \quad (34)$$

The actual output  $\hat{y}(z)$  is replaced by the current measurement  $y(z)$  to update the open-loop prediction  $\hat{y}^0(J, z)$  with disturbances and uncertainties present in the system. Then, the corrected open-loop prediction is given by

$$\hat{y}^0(J, z) = y(z) + \left[ \tilde{a}_J z^{-1} + \sum_{i=J+1}^N \tilde{h}_i z^{J-i} - \sum_{i=1}^N \tilde{h}_i z^{-i} \right] u(z), \quad (35)$$

or simply

$$\hat{y}^0(J, z) = y(z) + P(J, z^{-1})u(z). \quad (36)$$

## APPENDIX B: ROBUST STABILITY CONDITION

Using the open-loop predictor (2) and the discrete convolution, the characteristic closed-loop equation is given by

$$T(z) = 1 + \sum_{n=1}^w q_{n+v} z^{-n} + \tilde{a}_J z^{-1} \sum_{n=0}^v q_n z^{-n} + \sum_{n=0}^v q_n z^{-n} \sum_{i=J+1}^N \tilde{h}_i z^{J-i} + \sum_{n=0}^v q_n z^{-n} \sum_{i=1}^N (h_i - \tilde{h}_i) z^{-i} + \sum_{n=0}^v q_n z^{-n} \sum_{i=N+1}^{\infty} h_i z^{-i}. \quad (37)$$

The stability of the closed-loop system depends on both: the prediction time  $J$  and the controller parameters. It may be tested by any usual stability criteria. First, the following lemma is introduced.

**Lemma 1:** If the polynomial  $T(z) = \sum_{i=0}^{\infty} t_i z^{-i}$  has the property that

$$\inf_{|z| \geq 1} |T(z)| > 0,$$

then the related closed-loop system will be asymptotically stable [7]. Hence,

$$|T(z)| = 1 - \sum_{n=1}^w |q_{n+v} z^{-n}| - \tilde{a}_J \sum_{n=0}^v |q_n z^{-n-1}| - \sum_{n=0}^v \sum_{i=J+1}^N |q_n \tilde{h}_i z^{J-i-n}| - \sum_{n=0}^v \sum_{i=1}^N |q_n (h_i - \tilde{h}_i) z^{-i-n}| - \sum_{n=0}^v \sum_{i=N+1}^{\infty} |q_n h_i z^{-i-n}|$$

and using Lemma A.1 gives

$$\inf_{|z| \geq 1} |T(z)| \geq \inf_{|z| \geq 1} \left\{ 1 - \sum_{n=1}^w |q_{n+v} z^{-n}| - \tilde{a}_J \sum_{n=0}^v |q_n z^{-n-1}| - \sum_{n=0}^v \sum_{i=J+1}^N |q_n \tilde{h}_i z^{J-i-n}| - \sum_{n=0}^v \sum_{i=1}^N |q_n (h_i - \tilde{h}_i) z^{-i-n}| - \sum_{n=0}^v \sum_{i=N+1}^{\infty} |q_n h_i z^{-i-n}| \right\}.$$

The worst case happens when  $z=1$ , thus

$$1 - \sum_{n=1}^w |q_{n+v}| - \tilde{a}_J \sum_{n=0}^v |q_n| - \sum_{n=0}^v |q_n| \sum_{i=J+1}^N |\tilde{h}_i| - \sum_{n=0}^v |q_n| \sum_{i=1}^N |h_i - \tilde{h}_i| - \sum_{n=0}^v |q_n| \sum_{i=N+1}^{\infty} |h_i| > 0,$$

which is equivalent to

$$\frac{1 - \sum_{n=1}^w |q_{n+v}|}{\sum_{n=0}^v |q_n|} + \tilde{a}_J > \sum_{i=J+1}^N |\tilde{h}_i| + \sum_{i=1}^N |h_i - \tilde{h}_i| + \sum_{i=N+1}^{\infty} |h_i|. \quad (38)$$

The closed-loop stability depends on both parameters: the prediction time  $J$  and the controller parameters  $q_n$   $n=0, 1, \dots, v+w$ . So, for the controller design the prediction time  $J$  is fixed and then the parameters are tuned.

**Remark 4:** If the controller denominator verifies

$$\sum_{n=1}^w |q_{n+v}| = 1,$$

the stability condition (29) becomes

$$\tilde{a}_J > \sum_{i=J+1}^N |\tilde{h}_i| + \sum_{i=1}^N |h_i - \tilde{h}_i| + \sum_{i=N+1}^{\infty} |h_i|. \quad (39)$$

This condition was derived by Giovanini [14] for the predictive feedback controller. This equation means that the prediction time  $J$  and controller parameters  $q_n$   $n=0, 1, \dots, v+w$  could be independently fixing. The same result is obtained if  $v=1$  and  $q_{v+1} = -1$ .

## APPENDIX C: ANALYSIS CONTRACTIVE CONSTRAINTS

The discrete controller may be equivalently written using the general state-space representation, i.e.,

$$x^C(k+1) = A_C x^C(k) + B_C e(k), \quad x^C(0) = x_0^C, \quad (40)$$

$$u(k) = C_C x^C(k) + D_C e(k),$$

where  $x^C \in R^v$ ,  $e \in R$  and  $u \in R$ . Assuming load change  $d(k)=0$  for  $\forall k$ , and the time delay  $t_d=0$  for simplicity, the process model can also be written as

$$\begin{aligned} x(k+1) &= Ax(k) + Bu(k), \quad x(0) = x_0, \\ y(k) &= Cx(k), \end{aligned} \quad (41)$$

where  $x \in R^n$  is the state of the plant, and  $y \in R$ . The expressions (31) and (32) may be combined after substituting  $e(k)$  by

$$\begin{aligned} e(k) &= r(k) - y(k) \\ &= r(k) - Cx(k), \end{aligned}$$

and rearranged such that the whole closed-loop system is written in form,

$$\begin{aligned} X(k+1) &= A_S X(k) + B_S r(k), \quad X(0) = X_0, \\ u(k) &= C_U x(k) + D_U r(k), \\ y(k) &= C_Y x(k), \end{aligned} \quad (42)$$

where

$$X(k) = \begin{bmatrix} x(k) \\ x^c(k) \end{bmatrix}, \quad A_S = \begin{bmatrix} A - BD_C C & B_C C \\ -B_C C & A_C \end{bmatrix}, \quad B_S = \begin{bmatrix} BD_C \\ B_C \end{bmatrix}, \quad (43a)$$

$$C_Y = [C \ 0], \quad C_U = [-D_C C \ C_C], \quad D_U = [D_C]. \quad (43b)$$

Now, let us consider a change in the control variable at the time instant  $k+1$

$$\Delta u(k+1) = u(k+1) - u(k).$$

From (42)  $\Delta u(k+1)$  can be written as follow

$$\Delta u(k+1) = C_U \Delta X(k+1) + D_U \Delta r(k+1).$$

Then, substituting  $X(k+1)$  and rearranging

$$\Delta u(k+1) = C_U [(A_S - I)X(k) + B_S r(k)] + D_U \Delta r(k+1). \quad (44)$$

Given the initial condition  $X(0)$  and the input  $r(i) \forall i \in [0, k]$ , the solution to the first equation in (42) is

$$X(k) = A_S^k X(0) + \sum_{i=1}^k A_S^{i-1} B_S r(k-i). \quad (45)$$

Hence, the control increment in (44) can be written now as

$$\begin{aligned} \Delta u(k+1) &= C_U \left[ (A_S - I) A_S^k X(0) + (A_S - I) \sum_{i=1}^k A_S^{i-1} B_S r(k-i) \right. \\ &\quad \left. + B_S r(k) \right] + D_U \Delta r(k+1). \end{aligned}$$

Assuming a setpoint change from 0 to  $r_0$  at the time instant  $k=0$ , and  $X(0)=0$  for simplicity, the last expression becomes

$$\Delta u(k+1) = C_U \left[ (A_S - I) \sum_{i=1}^k A_S^{i-1} B_S r_0 + B_S r_0 \right]. \quad (45)$$

Recalling a property of geometric progressions now

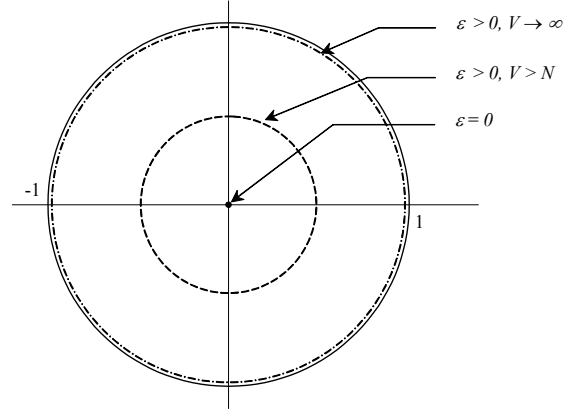

Fig. 14. Effect of parameters on the stability region.

we can write

$$\sum_{i=1}^k A_S^{i-1} B_S r_0 = (I - A_S)^{-1} (I - A_S^k) B_S r_0 \quad A_S \neq I, \quad (46)$$

substituting (46) into (45) and rearranging gives

$$\Delta u(k+1) = C_U A_S^k B_S r_0.$$

To visualize the effect of the *contractive constraint*

$$|\Delta u(k+1)| \leq \varepsilon \quad \varepsilon \ll 1 \quad (47)$$

on the location of closed-loop characteristic values, let us take a conservative condition using a property of the norm-2, i.e.

$$\left| C_U A_S^k B_S \right| \leq \|C_U\| \|A_S\|^k \|B_S\| \leq \frac{1}{|r_0|} \varepsilon.$$

Since  $C_U$ ,  $B_S$  and  $\bar{r}$  are different from zero, the last expression can be rewrite as

$$\|A_S\|^k \leq M \varepsilon, \quad (48)$$

where  $M = \|C_U\| \|B_S\| |r_0|$  is a positive quantity. Observe that if (48) is satisfied for the sampling instant  $k$ , it will also verify for all subsequent sampling instants. This also implies

$$\max_i |\lambda_i(A_S)| \leq \|A_S\| \leq (M \varepsilon)^{\frac{1}{k}}. \quad (49)$$

Using controlled form for the controller representation (40), it is verified that  $\|B_S\| \geq 1$  and  $\|C_U\| \geq 1$ , due to the presence of the integral mode in (40). Therefore, if  $\varepsilon$  is chosen as

$$\varepsilon < |r_0|$$

it is verified that  $M\varepsilon < 1$ , and the roots are enclosed by a circle whose diameter increases asymptotically up to 1 when  $k \rightarrow \infty$  (see Fig. 14). When  $\varepsilon=0$ , from (49) it is verified

$$\lambda_i(A_S) = 0 \quad \forall i. \quad (50)$$

**Remark 5:** Since condition (44) is equivalent to requiring both  $y$  and  $u$  remain constant after the time instant  $k+V$ , therefore, it ensures the internal stability of all open loop stable systems.

#### APPENDIX D: REACTOR MODEL

Consider the problem of controlling a continuous stirred tank reactor CSTR in which an irreversible exothermic reaction  $A \rightarrow B$  in constant volume reactor [23]. The following assumptions are made in the modeling the system: (a) perfect mixing, uniform concentration temperature; (b) constant volume and density; (c) heat losses are ignored; (d) jacket heat transfer resistance is negligible. The reaction occurs in a constant volume reactor cooled by a single coolant stream. The system can be modeled by the following equations.

$$\begin{aligned} \frac{dCa(t)}{dt} &= \frac{q(t)}{V} (Ca_O(t) - Ca(t)) - k_0 Ca(t) \exp\left(-\frac{E}{R T(t)}\right), \\ \frac{dT(t)}{dt} &= \frac{q(t)}{V} (T_O(t) - T(t)) - \frac{k_0 \Delta H}{\rho c_p} Ca(t) \exp\left(-\frac{E}{R T(t)}\right) \\ &\quad + \frac{\rho_C c_{pC}}{\rho c_p V} q_C(t) \left[ 1 - \exp\left(-\frac{hA}{q_C(t) \rho_C c_{pC}}\right) \right] (T_{CO}(t) - T(t)). \end{aligned} \quad (51)$$

The objective is to control the output concentration  $Ca(t)$  using the coolant flow rate  $q_C(t)$  as the

Table 4. Nominal CSTR parameters values.

Parameter	Signs	Values
Measured concentration	$Ca$	$0.1 \text{ mol } l^{-1}$
Reactor temperature	$T$	$438.5 \text{ K}$
Coolant flow rate	$q_C$	$103.41 \text{ lt } min^{-1}$
Process flow rate	$q$	$100 \text{ lt } min^{-1}$
Feed concentration	$Ca_O$	$1 \text{ mol } l^{-1}$
Feed temperature	$T_O$	$350 \text{ K}$
Inlet coolant temperature	$T_{CO}$	$350 \text{ K}$
CSTR volume	$V$	$100 \text{ lt}$
Heat transfer term	$hA$	$7.0 \cdot 10^5 \text{ cal } min^{-1} K$
Reaction rate constant	$k_0$	$7.2 \cdot 10^{10} \text{ min}^{-1}$
Activation energy	$E/R$	$10^4 \text{ K}^{-1}$
Heat of reaction	$\Delta H$	$-2.0 \cdot 10^5 \text{ cal } mol^{-1}$
Liquid densities	$\rho, \rho_C$	$10^3 \text{ g } l^{-1}$
Specific heats	$c_p, c_{pC}$	$1.0 \text{ cal } g K$

manipulated variable, and the inlet coolant temperature  $T_{CO}(t)$  (measurable) and the feed concentration  $Ca_O(t)$  (non-measurable) are the disturbances. The output concentration has a measured time delay of  $td=0.5 \text{ min}$ . The relative nominal values of the variables and their description are given in Table 4.

#### REFERENCES

- [1] A. Abbas, and P. Sawyer, "A multi-objective design algorithm: Application to the design of SISO control systems," *Computers Chem. Engng.*, vol. 19, no. 3, pp. 241-248, 1995.
- [2] J. Allwright and G. Papavasiliou, "On linear programming and robust model predictive control using impulse-responses," *System and Control Letters*, vol. 18, pp. 159-164, 1992.
- [3] T. Badgwell, "Robust model predictive control of stable linear systems," *International Journal of Control*, vol. 68, pp. 797-818, 1997.
- [4] A. Bemporad, "Reducing conservativeness in predictive control of constrained system with disturbances," *Proc. 37th IEEE Conference on Decision and Control*, pp. 2133-2138, 1998.
- [5] P. Campo and M. Morari, "Robust model predictive control," *Proc. American Contr. Conf.*, Minneapolis, MN, pp. 1021-1026, 1987.
- [6] V. Chankong and Y. Haimes, *Multiobjective Decision Making: Theory and Methodology*, Elsevier Science Publishing, 1983.
- [7] C. Desoer and M. Vidyasagar, *Feedback System: Input-Output Properties*, Academic Press, 1975.
- [8] T. Gal, "On efficient sets in vector maximum problems-A brief survey," *European Journal of Operational Research*, vol. 24, no 2, pp. 253-264, 1986.
- [9] C. Garcia, D. M. Prett, and M. Morari, "Model predictive control: Theory and practice-A survey," *Automatica*, vol. 25, no. 3, pp 335-348, 1989.
- [10] H. Genceli and M. Nikolaou, "Robust stability analysis of constrained  $l_1$ -norm model predictive control," *AIChE J.*, vol. 39, no. 8, pp. 1954-1965, 1993.
- [11] E. Gilbert and K. Tan, "Linear systems with state and control constraints: The theory and application of maximal output admissible," *IEEE Trans. Autom. Contr.*, vol. 36, no 10, pp. 1008-1019, 1991.
- [12] E. Gilbert and I. Kolmanovsky, "Maximal output admissible sets for discrete-time systems with disturbance inputs," *Proc. of the American Contr. Conf.*, pp. 2000-2005, 1995.
- [13] L. Giovanini and J. Marchetti, "Shaping time-domain response with discrete controllers," *Ind. Eng. Chem. Res.*, vol. 38, no. 12, pp. 4777-4789, 1999.



- [14] L. Giovanini, "Predictive feedback control," *ISA Transaction Journal*, vol. 42, no. 2, pp. 207-226, 2003.
- [15] M. V. Kothare, V. Balakrishanan, and M. Morari, "Robust constrained model predictive control using linear matrix inequalities," *Automatica*, vol. 32, no. 10, pp. 1361-1379, 1996.
- [16] B. Kouvaritakis, J. Rossiter, and Cannon, M. "Linear quadratic feasible predictive control," *Automatica*, vol. 34, no. 12, pp. 1583-1592, 1998.
- [17] B. Kouvaritakis, A. Rossiter, and J. Schuurmans, "Efficient robust predictive control," *IEEE Trans. Autom. Contr.*, vol. 45, no. 12, pp. 1545-1549, 2000.
- [18] J. Lee and Z. Yu, "Tuning of model predictive controllers for robust performance," *Computers Chem. Engng.*, vol. 18, no. 1, pp. 15-37, 1994.
- [19] J. Lee and Z. Yu, "Worst-case formulation of model predictive control for system with bounded parameters," *Automatica*, vol. 33, no. 5, pp. 763-781, 1997.
- [20] A. Malmgrem and A. Nordström, "A contraction property for state feedback design of linear discrete-time systems," *Automatica*, vol. 30, no. 9, pp. 1485-1489, 1994.
- [21] D. Mayne and E. Michalska, "Receding horizon control of nonlinear systems," *IEEE Trans. Autom. Contr.*, vol. 35, no. 5, pp. 814-824, 1990.
- [22] P. Maurath, A. Laub, D. Seborg, and D. Mellichamp, "Predictive controller design by principal component analysis," *Ind. Eng. Chem. Res.*, vol. 27, no. 5, pp. 1204-1212, 1988.
- [23] J. Morningred, B. Paden, D. Seborg, and D. Mellichamp, "An adaptive nonlinear predictive controller," *Chem. Eng. Sci.*, vol. 47, no. 4, pp. 755-765, 1992.
- [24] P. Sokaert and J. Rawlings, "Constrained linear quadratic regulation," *IEEE Trans. Autom. Contr.*, vol. 43, no. 9, pp. 1163-1169, 1998.
- [25] Y. Sawaragi, H. Nakayama, and T. Tanino, *Theory of Multiobjective Optimization*, Academic Press, 1985.
- [26] P. Van Overschee and B. De Moor, *Subspace Identification for Linear System*, Kluwer Academic Publisher, 1996.
- [27] P. Vuthandam, H. Genceli, and M. Nikolaou, "Performance bounds for robust quadratic dynamic matrix control with end condition," *AICHE*, vol. 41, no 9, pp. 2083-2097, 1995.
- [28] E. Zafiriou, "Robust model predictive control with hard constraints," *Computers Chem. Engng.*, vol. 14, no. 4-5, pp. 359-371, 1990.
- [29] Z. Zheng and M. Morari, "Stability of model predictive control with mixed constraints," *IEEE Trans. on Automatic Control*, vol. 40, no. 10, pp. 1818-1823, 1995.



**Leonardo Giovanini** received the BSc (Honors) degree in Electronic engineering from the Universidad Tecnológica Nacional (Argentina) in 1995, and the Ph.D. degree in Engineering Science from Universidad Nacional del Litoral (Argentina) in 2000. From 1998 until 2001 he was a Lecturer in the Department of Electronic Engineering at Universidad Tecnológica Nacional (Argentina). Since 2002 he has been working as Research Fellow in the Industrial Control Center, University of Strathclyde. He has published more than forty technical papers. His research interests include predictive control for non-linear systems, fault detection and isolation, fault tolerant control and distributed control systems.



**Michael John Grimble** was awarded a BSc (Coventry) in Electrical engineering in 1971, MSc, PhD and DSc degrees from the University of Birmingham in 1971, 1978 and 1982, respectively. Whilst in industry he took an Open University Degree studying mathematics and was awarded a BA in 1978. The University of Strathclyde, Glasgow, appointed him to the Professorship of Industrial Systems in 1981 and he developed the Industrial Control Centre combining fundamental theoretical studies and real applications research. He has published five books and well over 100 papers.

He is the managing editor of two journals he started including the *International Journal of Robust and Non-linear Control* and the *International Journal of Adaptive Control and Signal Processing*, both published by John Wiley Ltd. He is the joint managing editor of the Springer Verlag Monograph Series on *Advances in Industrial Control* and is an Editor of the Springer *Lecture Notes in Control and Information Sciences* series. He is also a managing editor of the Springer Verlag text book series on Control and Signal Processing. He was the editor of the Prentice Hall International series of books on *Systems and Control Engineering* and also the Prentice-Hall series on *Acoustics Speech and Signal Processing*.

The Institution of Electrical Engineers presented him with the *Heaviside Premium* in 1978 for his papers on control engineering. The following year, 1979, he was awarded jointly the *Coopers Hill War Memorial Prize and Medal* by the Institutions of Electrical, Mechanical and Civil Engineering. The Institute of Measurement and Control awarded him the 1991 *Honeywell International Medal*. He was appointed a Fellow of the Royal Society of Edinburgh in 1999. He was jointly awarded the Asian Journal of Control best paper award for 2002/2003.