

A Fuzzy Logic for Autonomous Navigation of Marine Vehicles Satisfying COLREG Guidelines

Sang-Min Lee, Kyung-Yub Kwon, and Joongseon Joh*

Abstract: An autonomous navigation algorithm for marine vehicles is proposed in this paper using fuzzy logic under COLREG guidelines. The VFF (Virtual Force Field) method, which is widely used in the field of mobile robotics, is modified for application to the autonomous navigation of marine vehicles. This Modified Virtual Force Field (MVFF) method can be used in either track-keeping or collision avoidance modes. Moreover, the operator can select a track-keeping pattern mode in the proposed algorithm. The collision avoidance algorithm has the ability to handle static and/or moving obstacles. The fuzzy expert rules are designed deliberately under COLREG guidelines. An extensive simulation study is used to verify the proposed method.

Keywords: Modified virtual force field, collision avoidance, marine vehicles, fuzzy logic, moving obstacles, COLREG.

1. INTRODUCTION

The autonomous navigation of marine vehicles is gaining increasing attention due to the inherent difficulties in their manual navigation and control. To this end, the research reported in the literature generally uses methods based on modern control theory [2,4,5,11,16]. These methods, however, require precise mathematical models of the dynamic behavior of the given marine vehicle and its immediate environment. Conversely, the operating environment of marine vehicles is often complicated and dynamic modeling of the vehicles themselves is surrounded in uncertainty. Therefore, an approach using artificial intelligent and soft computing may be a promising choice as reported in the literature [1,3,6,8,13-15]. The approach proposed herein attempts to combine the heuristic perspectives offered in these works with the notion of VFF (Virtual Force Field), which has been successfully used in mobile robotics, especially in addressing the problem of obstacle avoidance [7,12]. The basic concept, as shown in Fig. 1, is that the goal attracts the

mobile robot while the obstacle repels it, as in the case of electric charges. This method works well for static obstacles. Marine vehicles, however, frequently face moving objects. Moreover, there usually exists a predetermined track (usually the shortest path between neighboring points), which the marine vehicle must follow as precisely as possible. Furthermore, COLREG¹ guidelines must be followed for secure collision avoidance. The original VFF method, however, also fails to offer the flexibility and robustness needed to address this concern, which is important in the navigation of marine vehicles.

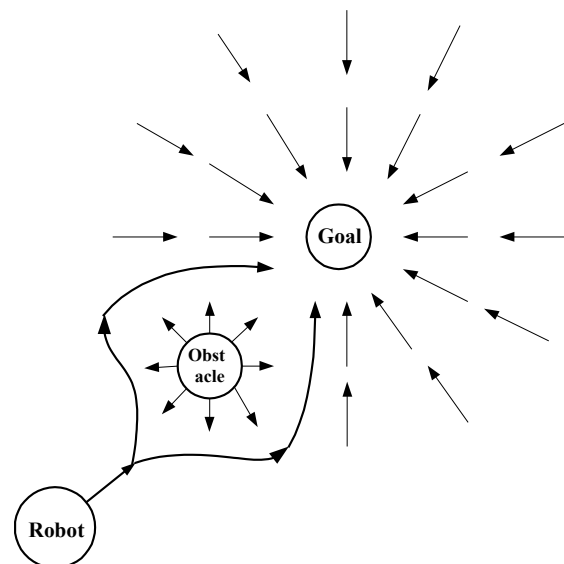

Fig. 1. The basic concept of the VFF method.

Manuscript received July 16, 2003; revised January 7, 2004; accepted January 9, 2004. Recommended by Editorial Board member Jin Young Choi under the direction of Editor Keum-Shik Hong. This work was supported by the Agency for Defense Development (ADD) through ADD-00-6-2.

Sang-Min Lee and Kyung-Yub Kwon are with the Dept. of Control & Instrumentation Eng, Graduate School of Changwon National University, 9 Sarim-dong, Changwon, Kyungnam, 641-773, Korea (e-mail: smlee@iname.com, kykwon@changwon.ac.kr).

Joongseon Joh is with the Dept. of Control & Instrumentation Eng, Changwon National University, 9 Sarim-dong, Changwon, Kyungnam, 641-773, Korea (e-mail: jsjoh@sarim.changwon.ac.kr).

* Corresponding author.

¹ The Rules of the Road International Regulations for Avoiding Collisions at Sea:

<http://www.boatsafe.com/nauticalknowhow/boating/colregs.html>.

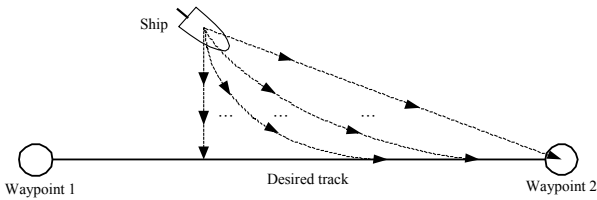

Fig. 2. The concept of track-keeping mode.

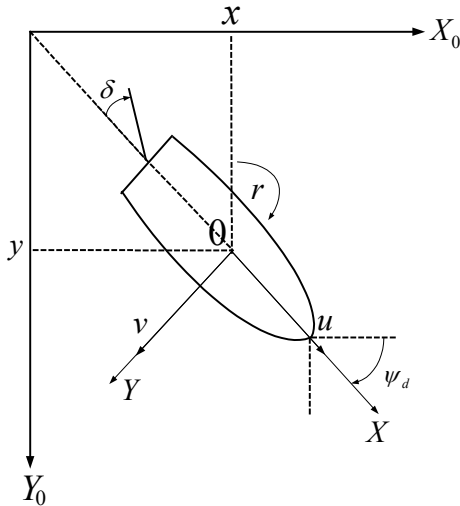

Fig. 3. An illustration of the control command.

Consequently, we offer a modified VFF, which is capable of operating in either ‘track-keeping’ or ‘collision avoidance’ modes. In the first mode, depicted in Fig. 2, the objective is to bring the vehicle to the desired track presuming that it is gone astray from this track. This mode is investigated thoroughly in Sections 2 and 3. The second mode is named ‘collision avoidance mode’. This mode can handle static and/or moving obstacles under COLREG guidelines. Four linguistic, i.e., fuzzy variables are used in the premise part of each rule to address possible collision effects. This mode is discussed in Section 4.

2. CONCEPTUAL BASIS OF THE PROPOSED MVFF METHOD

The primary control command in marine vehicle navigation is the heading angle, which is affected via the rudder as shown in Fig. 3. In the figure, $\{X_0, Y_0\}$ and $\{X, Y\}$ are the global and the body-fixed coordinate systems, respectively; (x, y) is the location of the center of gravity of the marine vehicle with respect to the global coordinate system; u , v , and r are the longitudinal, transverse, and angular velocities, respectively; δ is the rudder angle and ψ_d is the desired heading angle.

Control of marine vehicles is usually carried out via

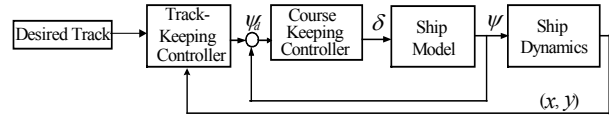

Fig. 4. A typical scheme to control marine vehicles.

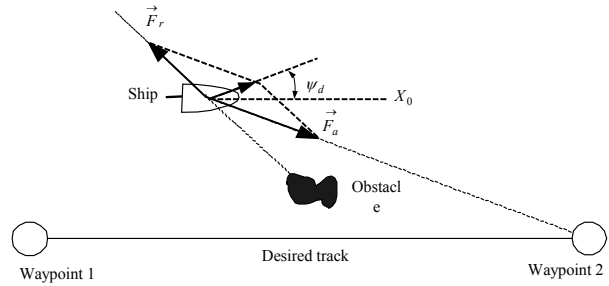

Fig. 5. Direct application of VFF method.

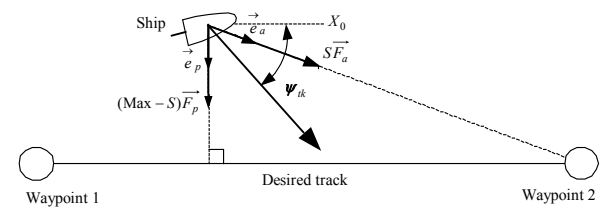

Fig. 6. The concept of track-keeping mode of MVFF.

a combination of inner and outer loops as illustrated in Fig. 4. The inner, course-keeping controller attempts to follow the heading angle command while the outer, track-keeping controller determines the desired heading in relation to the desired track. The approach proposed here, however, is inspired by the VFF method whose direct application is depicted in Fig. 5.

As shown in the figure, the vehicle is assumed to be under the influence of two forces at any given point in time: \vec{F}_a which acts to pull the vehicle towards the next waypoint, and \vec{F}_r , a force directed away from the given obstacle. Evidently, a simple application of VFF does not provide track-keeping in its true sense. Moreover, in the case of a moving obstacle, a single forcing function \vec{F}_r is insufficient to address the situation adequately, particularly when the vehicle is within the proximity of multiple obstacles.

The proposed algorithm modifies the VFF method to provide true track keeping capability in conjunction with COLREGS-based collision avoidance in the presence of moving obstacles. Fig. 6 illustrates the underlying framework for track keeping where in addition to \vec{F}_a as defined earlier, \vec{F}_p represents a force component perpendicular to the desired track.

These forces are defined as

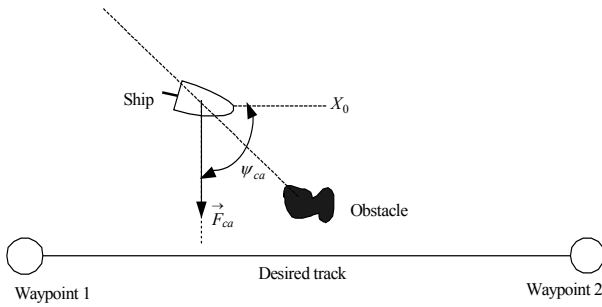

Fig. 7. The concept of the proposed collision avoidance.

$$\vec{F}_a = \alpha \vec{e}_a \quad (1)$$

and

$$\vec{F}_p = \beta \vec{e}_p, \quad (2)$$

where \vec{e}_a is the unit vectors directed towards the next waypoint while \vec{e}_p is orthogonal to \vec{e}_a and is directed towards the desired track. The parameters α and β are determined using a set of fuzzy rules, and the vector addition of \vec{F}_a and \vec{F}_p defines the required command for heading angle.

A properly designed set of fuzzy rules for α and β provides a *standard return mode* for the marine vehicle to reach the desired track from its initial, deviated location. If the vehicle is too far from the desired track, α is very small and β is very large. On the other hand, if it is in very close proximity to the desired track, α is very large and β is very small. A more detailed discussion of α and β is given in Section 3.

Flexibility in choosing the return mode is introduced in terms of the concept of *mode number*. (3) explains this concept where

$$\psi_{tk} = \text{angle}(S\vec{F}_a + (\text{Max} - S)\vec{F}_p), \quad (3)$$

with S as the mode number defined as $S \in [0, \text{Max}]$ and Max is pre-determined off-line via simulation for the specific marine vehicle. The function, $\text{angle}(\cdot)$, yields the angle of the vector input with respect to $\{X_0, Y_0\}$ and ψ_{tk} is the heading angle command for the vehicle to maintain the desired track. If S approaches Max , greater emphasis is placed on approaching the next waypoint. If S approaches zero, greater emphasis is placed on quick return to the desired track. COLREGS-based collision avoidance in the proposed algorithm is quite different from that of the original VFF method. Fig. 7 illustrates the basic concept of the proposed collision avoidance idea.

In particular, \vec{F}_r in the original VFF lies on the ex-

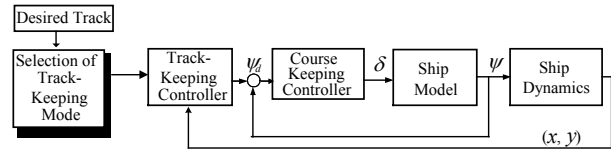

Fig. 8. Block diagram for the proposed algorithm.

tended line between the marine vehicle and the obstacle as shown in Fig. 5. The direction of \vec{F}_{ca} , which plays a similar role in MVFF as \vec{F}_r does in VFF, is not, however, directly related to the obstacle and is determined using a set of fuzzy rules. These fuzzy rules have four linguistic variables in their premise part and are designed to cope with different cases of possible collision. This is investigated further in Section 4. In brief, however, the heading angle for collision avoidance mode is given by

$$\psi_{ca} = \text{angle}(\vec{F}_{ca}), \quad (4)$$

where ψ_{ca} is the heading angle to avoid collision.

Now, the combination of (3) and (4) yields the heading angle commands for the marine vehicle as follows:

$$\psi_d = \psi_{tk} + \psi_{ca}. \quad (5)$$

(5) provides the basis for the proposed unified framework for autonomous navigation of marine vehicles. Fig. 8 shows the overall block diagram for the proposed algorithm where a simple PID control scheme is used for the ‘course-keeping controller’ with a sampling time much faster (say, 10 times) than the outer loop ‘track-keeping/collision avoidance’ controller.

3. DETERMINATION OF ψ_{tk}

In general, navigating a ship requires understanding the setting in which the ship operates in. In particular, the waters around the ship may be classified as either “danger region” or “safe region” depending on whether the vehicle is close to the border of the territorial waters of another country. Moreover, the patterns of autonomous navigation in these two regions must be different. The ship must return to the desired track as soon as possible if it is operating in the danger region as shown in Fig. 9. However, in the safe region, the given vehicle may return to the desired track in various ways as implied in (1) through (3). In particular, the values of α and β determine the representative behavior of a ship in the “danger” and “safe” regions. The choice of the return pattern in the safe region is implemented by selecting S .

In more specific terms, quick escape motion in the danger region is implemented by assigning $\alpha = 0$ and

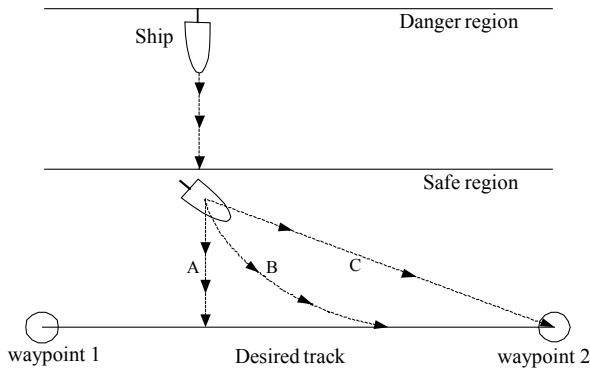

Fig. 9. Danger region and safe region.

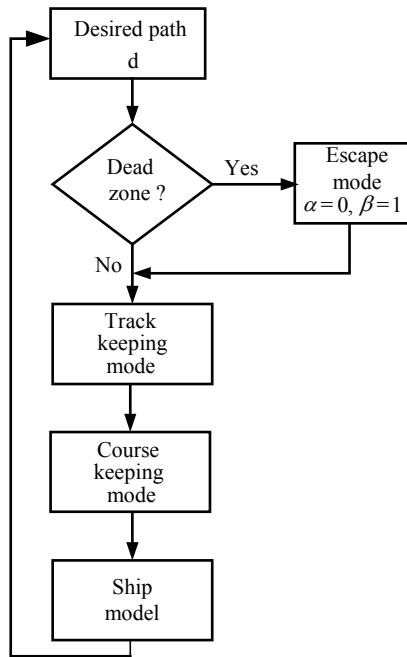

Fig. 10. Escape motion in the danger region.

$\beta = 1$ as illustrated in Fig. 10. In the so called safe region, α and β are, however, are determined via fuzzy rules:

- R_1 : IF d is *Near* THEN α is B and β is S ,
- R_2 : IF d is *Middle* THEN α is M and β is M , (6)
- R_3 : IF d is *Far* THEN α is S and β is B ,

where the linguistic variable d denotes the shortest distance of the given marine vehicle from the pre-determined desired path and has {Near, Middle, Far} its term set as shown in Fig. 11. The term set for α and β is {S(mall), M(edium), B(ig)} and the corresponding membership functions are represented in Fig. 12.

Note that if α is much greater than β then the marine vehicle will head to the next waypoint as shown in Fig. 6. On the other hand, if β is much greater than

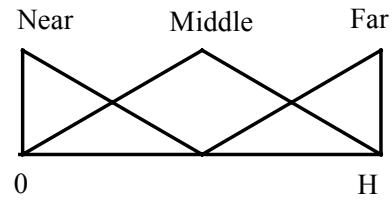

Fig. 11. Term set for the linguistic variable d .

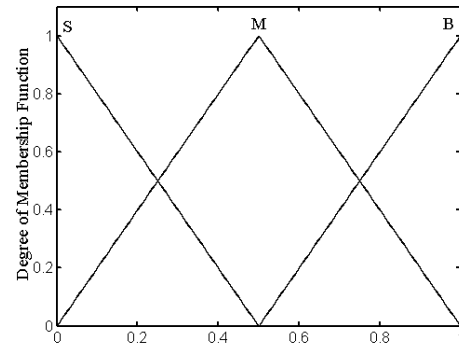

Fig. 12. Term set for α and β .

α then the marine vehicle will move towards the desired path as soon as possible. Therefore, (6) indicates that the emphasis in the motion of the marine vehicle is to return to the pre-determined desired path when the marine vehicle has moved too far from the given path. Alternatively, the next way-point receives more emphasis when the marine vehicle is near the pre-determined desired path. Fuzzy logic provides a good blending between these two extreme cases.

4. DETERMINATION OF ψ_{ca}

Basically, the VFF method yields good collision avoidance performance, particularly for static obstacles. However, collision situations for marine vehicles are generally complex as noted in COLREG guidelines. For instance, Rule 8 in COLREG guidelines requires strict safety precautions in view of both the direction of motion of the vehicles involved as well as their relative speed. While it is generally difficult to translate these guidelines into a computationally tractable strategy, this section is meant to illustrate the fact that the proposed approach addresses the key aspects of these guidelines. In particular, Fig. 13 shows the space surrounding a marine vehicle.

Representative locations of possible static or moving obstacles are marked as circled numbers. The front half of the space to which the marine vehicle advances is divided more precisely than the rear half space since the majority of collisions occur in this space. The obstacles can be static or dynamic. The direction of the moving obstacles can be towards or away from the marine vehicle. The original VFF is not sufficiently

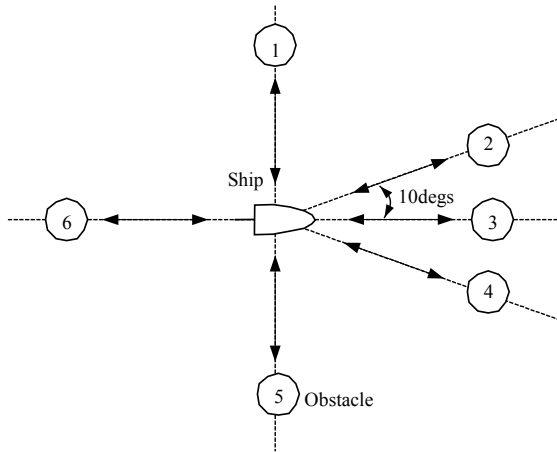

Fig. 13. Representative locations of obstacles.

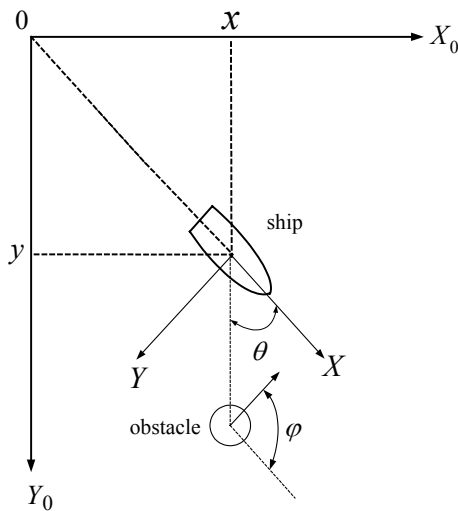

Fig. 14. Meaning of θ and φ .

flexible to handle these complicated situations. The proposed MVFF method introduces the concept of the vector of collision avoidance, illustrated in Fig. 7. This vector is determined via fuzzy rules having four linguistic variables in their premise part. Equation (7) represents the i^{th} generic fuzzy rule yielding angle(\vec{F}_{ca}):

$$\begin{aligned} \text{IF } d_{obs} \text{ is } (LVd_{obs})_i \text{ and } v_{rel} \text{ is } (LVv_{rel})_i \\ \text{and } \theta \text{ is } (LV\theta)_i \text{ and } \varphi \text{ is } (LV\varphi)_i \quad (7) \\ \text{THEN angle is } (LV\text{angle}(\vec{F}_{ca}))_i, \end{aligned}$$

where LV^* is a linguistic value of the linguistic variable $*$; d_{obs} is the distance between the ship and the obstacle; v_{rel} is the absolute value of the relative velocity between the ship and the obstacle; θ is the location of the obstacle with respect to the ship; and φ is the moving direction of the obstacle measured with

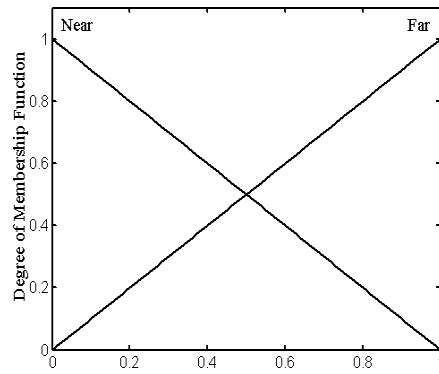

Fig. 15. Term set for d_{obs} (nm).

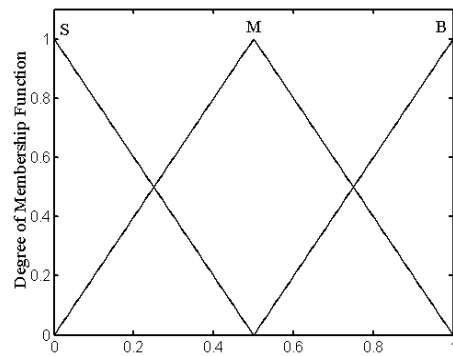

Fig. 16. Term set for v_{rel} (nm/min).

moving direction of the obstacle measured with respect to the local coordinate system attached to the ship. COLREG guidelines are implemented in equation (7) as follows,

1. Positive value for $LV\text{angle}^*$ in the equation (7) guarantees a right turn when collision avoidance occurs;
2. Passing direction is fixed to the right turn in this paper for simplicity of the algorithm even though COLREGS allows right and left turns; and,
3. Collision avoidance rules are not applied when passing action by the other vehicles is detected in order to follow the COLREGS guidelines.

Fig. 14 illustrates the meaning of θ and φ . The term sets \vec{F}_{ca} of the four linguistic variables are illustrated in Figs. 15 ~ 18. Fig. 15 represents the term set for the linguistic variable d_{obs} . It consists of {Near, Far}. Fig. 16 represents the term set for the linguistic variable v_{rel} . It consists of {S(mall), M(edium), B(ig)}. Fig. 17 represents the term set for the linguistic variable θ . It consists of {LB, LS, LF, F, RF, RS, RB}. L and R denote 'Left' and 'Right'. B, S, and F signify 'Back', 'Side', and 'Front', respectively. Fig. 18 represents the term set for the linguistic variable φ . It consists of {LB, LS, F, RS, RB}.

The resulting combinations of linguistic variables

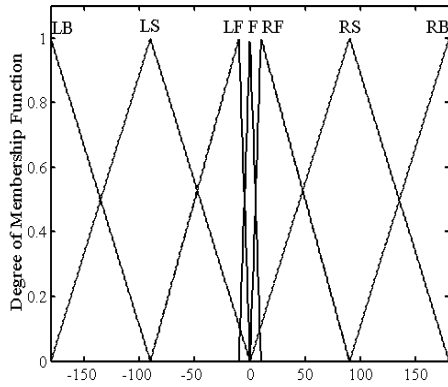

Fig. 17. Term set for θ (degree).

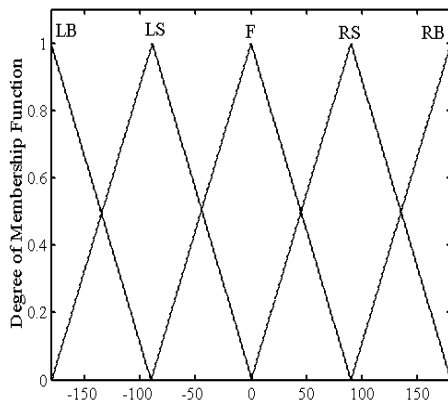

Fig. 18. Term set for φ (degree).

and their associated term sets result in 210 fuzzy rules as listed in Table 1. As an example, the rule

IF d_{obs} is *Near* and v_{rel} is *S*
 and θ is *LF* and φ is *LS*
 THEN $\text{angle}(\vec{F}_{ca})$ is 22.5.

This means that if the distance to the obstacle is ‘Near’, the relative velocity between the ship and ob
 The proposed algorithm in this paper is able to set the collision avoiding distance r . (Refer to Fig. 22.) The position of the marine vehicle is the center of the circle of radius r and the circle plays the role of the onset of the collision avoiding action. This means that the algorithm ignores obstacles outside the circle but it activates its collision avoiding action whenever the stacle is ‘Small’, the obstacle is located at ‘Left Front’, and the moving object is approaching from ‘Left Side’, then the vector for collision avoidance is directing 22.5 degree.

The proposed algorithm in this paper is able to set the collision avoiding distance r . (Refer to Fig. 22.) The position of the marine vehicle is the center of the

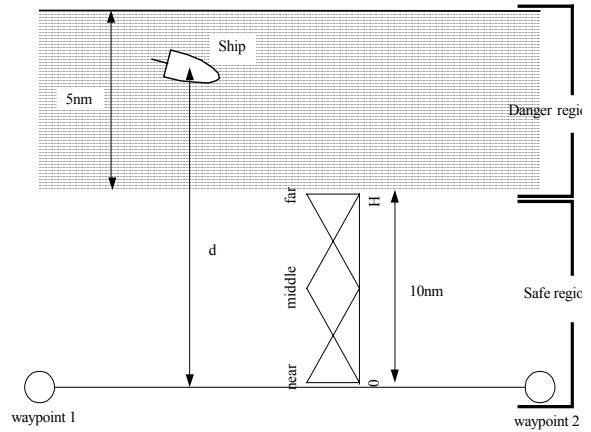

Fig. 19. Danger and safe regions.

circle of radius r and the circle plays the role of the onset of the collision avoiding action. This means that the algorithm ignores obstacles outside the circle but it activates its collision avoiding action whenever the obstacles are inside the circle. The radius r can be set by the operator appropriately. Therefore, with the assumption of no existence of obstacles within the circle at the onset of the collision avoiding algorithm, the collision can always be avoided.

5. SIMULATIONS

A marine vehicle used for verification of the proposed algorithm is modeled as follows,

$$\begin{aligned} \dot{x} &= u \cos \psi - v \sin \psi, \\ \dot{y} &= u \sin \psi + v \cos \psi, \\ \dot{\psi} &= r, \\ \dot{r} &= -ar - br^3 + c\delta, \\ \dot{u} &= -fu - Wr^2 + S, \\ v &= -g_1u - g_2v_1^3, \end{aligned} \tag{8}$$

where a, b, c, f, W, S, g_1 , and g_2 are the ship model parameters and given as $a = 1.084/\text{min}$, $b = 0.62/\text{min}$, $c = 3.553/\text{min}$, $f = 0.86/\text{min}$, $W = 0.067\text{nm}/\text{rad}^2$, $S = 0.215\text{nm}/\text{min}^2$, $g_1 = -0.0375\text{nm}/\text{min}$, and $g_2 = 0$ and where nm is the unit of nautical mile and 1 nm is equal to 1,852 meters.

This model is cited from [11]. The angle and rate of the rudder is limited as $-35 \sim +35$ degree and $-120 \sim +120$ degree/min for simulation. The radius of the collision avoiding circle is set to 4 nm . It is assumed that there exist only surge, sway, and yaw motions.

5.1. Simulations for track-keeping mode

Track-keeping ability of the proposed algorithm is investigated in this subsection. Way points used are as follows,

Table 1. Consequent parts of the 210 fuzzy rules.

	1	2	3	4	5	6	7	8	9	10	11	12	13	14	15	16	17	18	19	20	21
1	0.0	0.0	22.5	0.0	0.0	67.5	0.0	0.0	45.0	67.5	0.0	0.0	22.5	0.0	0.0	0.0	22.5	0.0	0.0	67.5	0.0
2	0.0	22.5	45.0	22.5	22.5	67.5	45.0	0.0	67.5	90.0	67.5	0.0	22.5	0.0	0.0	22.5	45.0	22.5	0.0	67.5	45.0
3	22.5	0.0	0.0	22.5	0.0	22.5	0.0	67.5	0.0	0.0	67.5	0.0	22.5	0.0	22.5	0.0	0.0	22.5	0.0	22.5	0.0
4	22.5	45.0	22.5	0.0	45.0	67.5	0.0	67.5	90.0	67.5	0.0	0.0	22.5	0.0	22.5	45.0	22.5	0.0	45.0	67.5	0.0
5	0.0	22.5	0.0	0.0	0.0	67.5	0.0	0.0	67.5	45.5	0.0	0.0	22.5	0.0	0.0	22.5	0.0	0.0	0.0	67.5	0.0
6	0.0	45.0	0.0	0.0	22.5	45.5	0.0	0.0	90.0	0.0	0.0	0.0	0.0	0.0	0.0	45.0	0.0	0.0	22.5	45.0	0.0
7	0.0	45.0	22.5	0.0	45.0	67.5	45.0	22.5	90.0	67.5	0.0	0.0	22.5	0.0	0.0	45.0	22.5	0.0	45.0	67.5	45.0
8	0.0	22.5	0.0	45.0	0.0	0.0	45.0	22.5	22.5	0.0	0.0	0.0	0.0	0.0	0.0	22.5	0.0	45.0	0.0	0.0	45.0
9	22.5	45.0	0.0	45.0	67.5	45.0	0.0	67.5	90.0	0.0	0.0	22.5	0.0	0.0	22.5	45.0	0.0	45.0	67.5	45.0	0.0
10	0.0	45.0	0.0	0.0	45.0	22.5	0.0	0.0	90.0	0.0	0.0	0.0	0.0	0.0	0.0	45.0	0.0	0.0	45.0	22.5	0.0

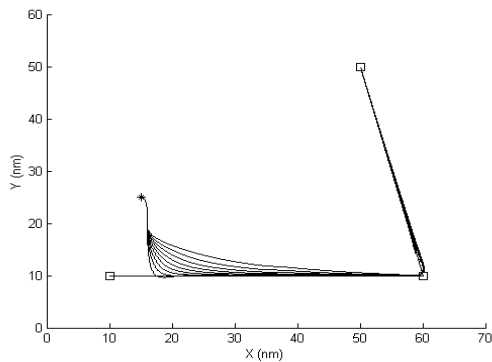

Fig. 20. Escaping from danger region with various return modes.

Way Point 1: $x = 10\text{nm}$, $y = 10\text{nm}$,

Way Point 2: $x = 60\text{nm}$, $y = 10\text{nm}$,

Way Point 3: $x = 50\text{nm}$, $y = 50\text{nm}$,

and they are marked as small circles in the figures discussed below.

Simple P-controller with gain $K_p = 0.08$ is used as a course-keeping controller for all of the simulations. Fig. 19 shows the danger and safe regions. Widths of these regions are set to 5 nm and 10 nm, respectively.

Simulation A. Escaping from the danger region under various return modes

The purpose of this simulation is to investigate the performance of the proposed approach in escaping from the danger region with various returning modes.

The location of the marine vehicle is set to $x = 15\text{nm}$, $y = 25\text{nm}$. S is selected in the interval $[0, 10]$ to show the gradual transition of the return mode from A to C. Max is set to 10. Fig. 20 represents the simulation results. It can be seen that the marine vehicle escapes from the danger region very quickly and various return modes, S , are performed well as ex-

pected.

5.2. Collision avoidance

This subsection investigates the collision avoidance performance of the proposed algorithm. Possibility of escaping from the danger region and the selection of a return mode are still maintained. In other words, the collision avoidance mode is augmented to the algorithm in subsection 5-1 to enhance the autonomous navigation capability of the system. Note that obstacles are classified as 'static' and 'moving'. For the moving obstacles, 8 different situations are examined. The fuzzy collision avoiding rules for static and/or moving obstacles are designed to follow COLREG guidelines.

Simulation B. Static Obstacles

The locations of the ship for Fig. 21 are set to $(x = 15\text{nm}, y = 25\text{nm})$, $(x = 20\text{nm}, y = 11\text{nm})$, and $(x = 35\text{nm}, y = 10\text{nm})$ for the simulations (a), (b), (c), and (d), respectively. As stated before, this location is within the danger region. Mode parameters S and Max are set to 1 and 10, respectively. Fig. 21 shows that the proposed algorithm works very well in the presence of static obstacles, which are placed at arbitrary locations as shown in Fig. 21(a)-(d). In each case, the algorithm functions as intended in terms of leading the ship towards its desired path/waypoint while avoiding collision with the obstacle even if the obstacle appears immediately after the ship has apparently reached its desired path as in Fig. 21(d).

Simulation C. Moving Obstacles

The proposed collision avoidance algorithm is designed to handle various situations of moving obstacles under COLREGS guidelines. Fig. 22 illustrates 8 different cases of a moving obstacle. The circled numbers represent moving obstacles and the arrows indicate their moving directions. Simulations are performed for each obstacle.

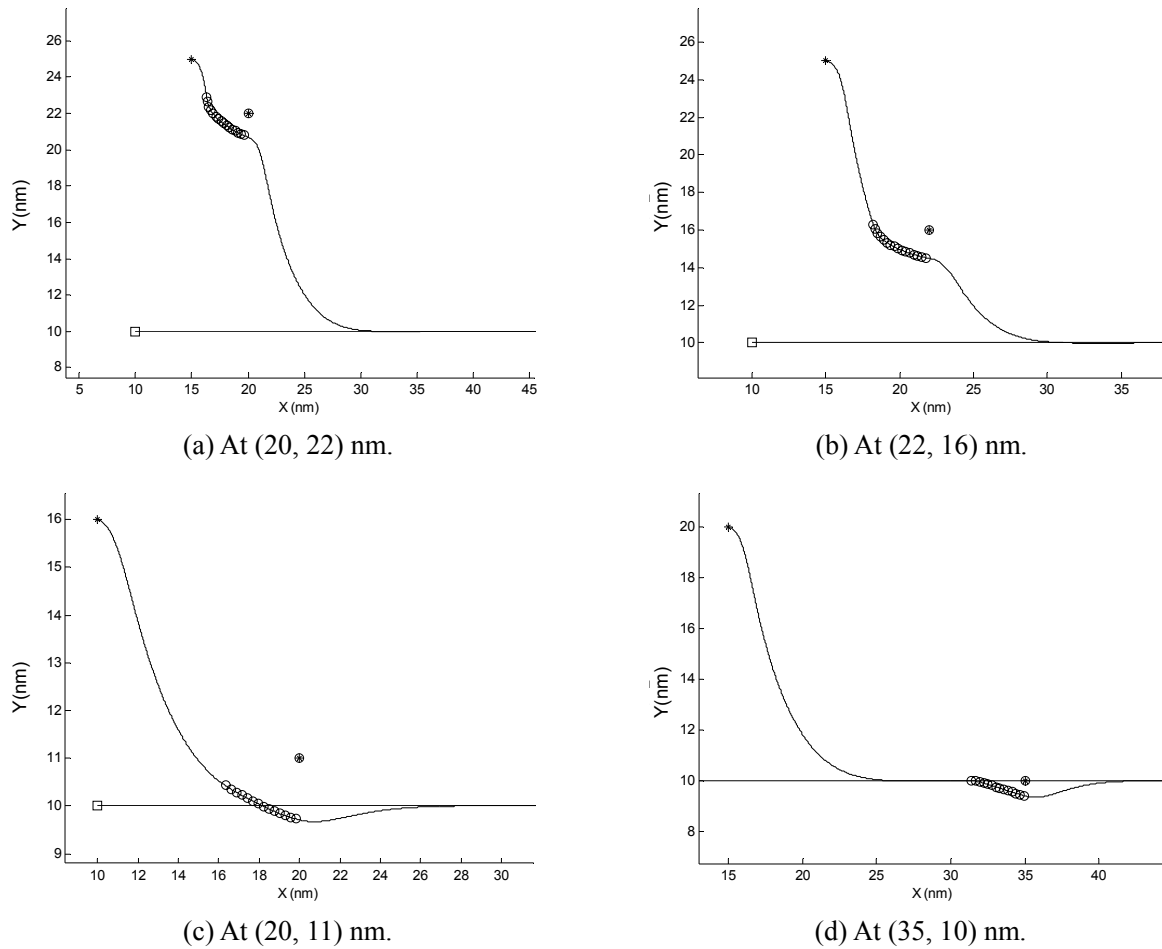

Fig. 21. Collision avoidance in the presence of a static obstacle.

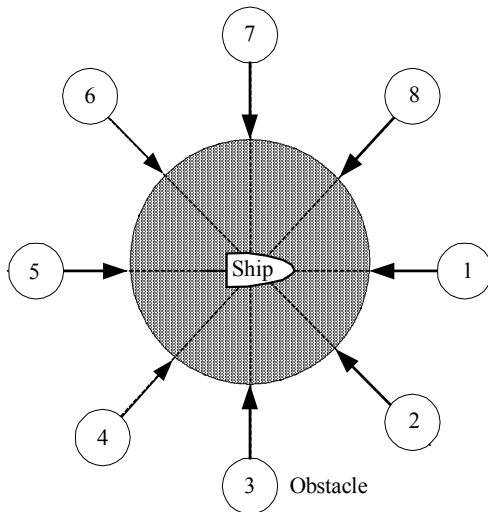

Fig. 22. An illustration of moving obstacles.

In Fig. 23, the locations of the ship and the obstacle are $(x, y)_{ship} = (37, 10)$ nm and $(x, y)_{obs} = (40, 10)$ nm, respectively. The corresponding velocities are $\vec{v}_{ship} = (0.275, 0)$ nm/min and $\vec{v}_{obs} = (-0.13, 0)$ nm/min. As the

figure depicts, the proposed algorithm avoids the moving obstacle approaching from the front quite well. In particular, the ship moves to the right and distances itself sufficiently well in advance of the moving obstacle to avoid a catastrophic collision.

In Fig. 24, the locations of the ship and the obstacle are $(x, y)_{ship} = (37, 10)$ nm and $(x, y)_{obs} = (42, 9)$ nm, respectively. The corresponding velocities are $\vec{v}_{ship} = (0.275, 0)$ nm/min and $\vec{v}_{obs} = (-0.04, 0.08)$ nm/min. As the figures shows, while considering the approach velocity of the obstacle, the ship moves away and in front of the obstacle to avoid collision. It is important to note that this maneuver strictly follows COLREG regulations in terms of avoiding crossing the path of a moving object.

In Fig. 25, the locations of the ship and the obstacle are $(x, y)_{ship} = (37, 10)$ nm and $(x, y)_{obs} = (42, 9)$ nm, respectively. The corresponding velocities are $\vec{v}_{ship} = (0.275, 0)$ nm/min and $\vec{v}_{obs} = (0, 0.08)$ nm/min. The figure shows that the proposed algorithm avoids the moving obstacle approaching from the right side effectively although once again the ship does cross the path of the moving obstacle. (The same comments

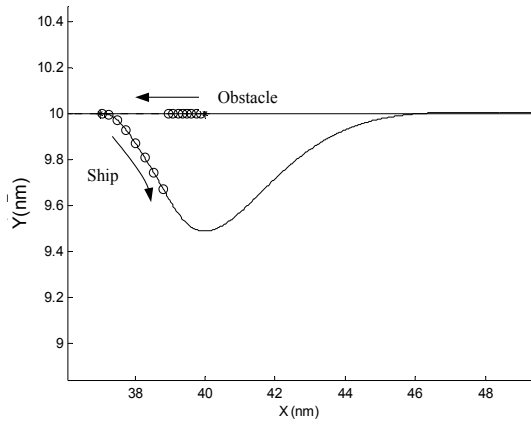

Fig. 23. Avoiding an obstacle approaching from the front.

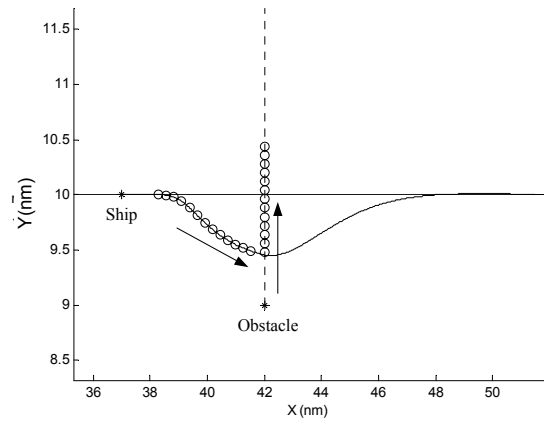

Fig. 25. Avoiding an obstacle approaching from the right.

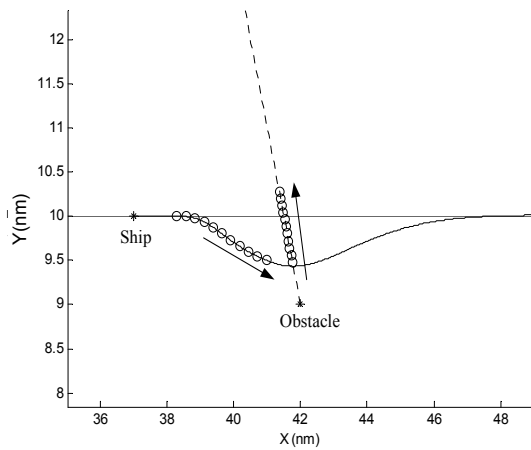

Fig. 24. Avoiding an obstacle approaching from the right front.

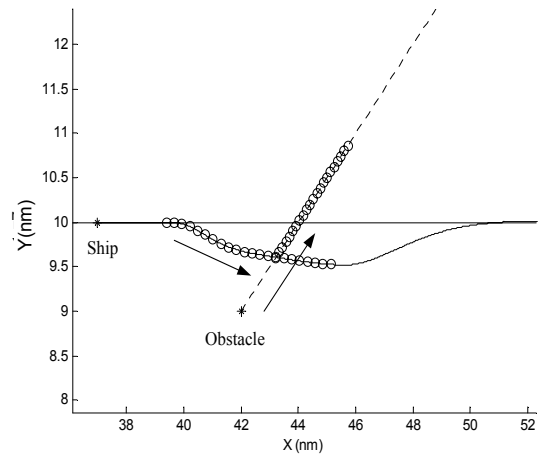

Fig. 26. Avoiding an obstacle approaching from the back right.

given above apply.)

In Fig. 26, the locations of the ship and the obstacle are $(x, y)_{ship} = (37, 10)$ nm and $(x, y)_{obs} = (42, 9)$ nm, respectively. The corresponding velocities are $\vec{v}_{ship} = (0.275, 0)$ nm/min and $\vec{v}_{obs} = (0.12, 0.06)$ nm/min. Fig. 26 shows that the proposed algorithm effectively avoids the moving obstacle approaching from the back right. Once again, the comments stated in relation to Fig. 24 are applicable in this case.

In Fig. 27, the locations of the ship and the obstacle are $(x, y)_{ship} = (37, 10)$ nm and $(x, y)_{obs} = (40, 12)$ nm, respectively. The corresponding velocities are $\vec{v}_{ship} = (0.275, 0)$ nm/min and $\vec{v}_{obs} = (0.05, -0.075)$ nm/min. The figure shows that the proposed algorithm avoids the moving obstacle approaching from the back left.

In Fig. 28, the locations of the ship and the obstacle are $(x, y)_{ship} = (37, 10)$ nm and $(x, y)_{obs} = (40, 12)$ nm, respectively. The corresponding velocities are $\vec{v}_{ship} =$

$(0.275, 0)$ nm/min and $\vec{v}_{obs} = (0, -0.08)$ nm/min. Once again, as the figure depicts, the proposed algorithm avoids the moving obstacle approaching from the left side although as noted previously the ship does cross the intended path of the moving obstacle.

In Fig. 29, the locations of the ship and the obstacle are $(x, y)_{ship} = (37, 10)$ nm and $(x, y)_{obs} = (44, 12)$ nm, respectively. The corresponding velocities are $\vec{v}_{ship} = (0.275, 0)$ nm/min and $\vec{v}_{obs} = (-0.05, -0.07)$ nm/min. The figure shows that the proposed algorithm avoids the moving obstacle approaching from the front left.

In Fig. 30, the locations of the ship and the obstacle are $(x, y)_{ship} = (37, 10)$ nm and $(x, y)_{obs} = (44, 10)$ nm, respectively. The corresponding velocities are $\vec{v}_{ship} = (0.275, 0)$ nm/min and $\vec{v}_{obs} = (0.1, 0.0)$ nm/min. The proposed algorithm provides good passing ability and it always passes to the right direction. This is done on purpose in order to follow the COLREGS guidelines as simply as possible.

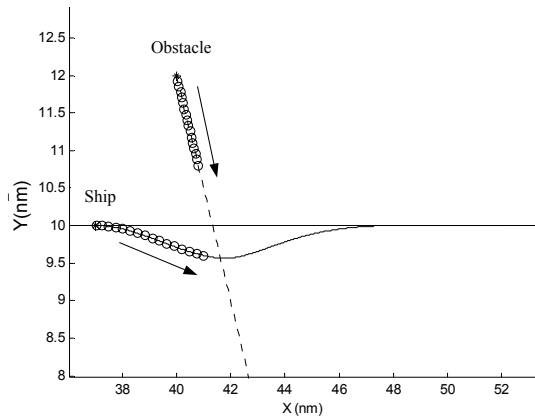

Fig. 27. Avoiding an obstacle approaching from the back left.

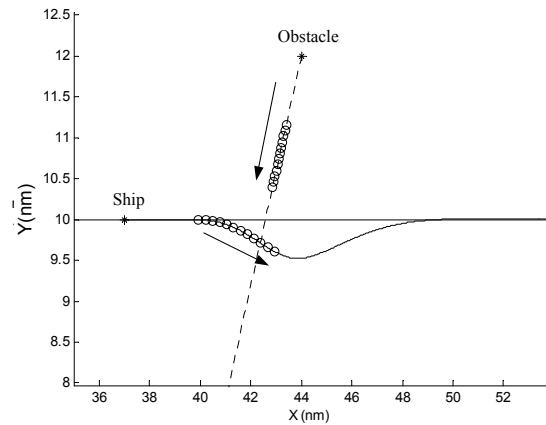

Fig. 29. Avoiding an obstacle approaching from the front left.

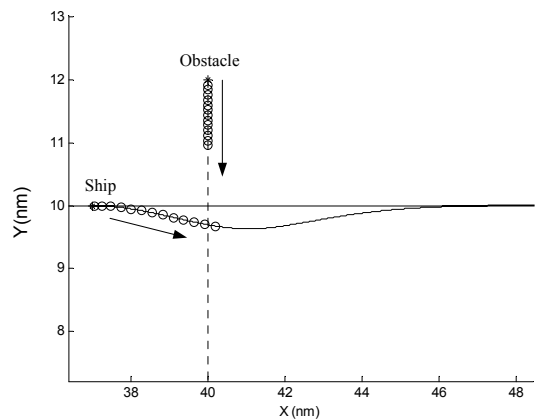

Fig. 28. Avoiding an obstacle approaching from the left.

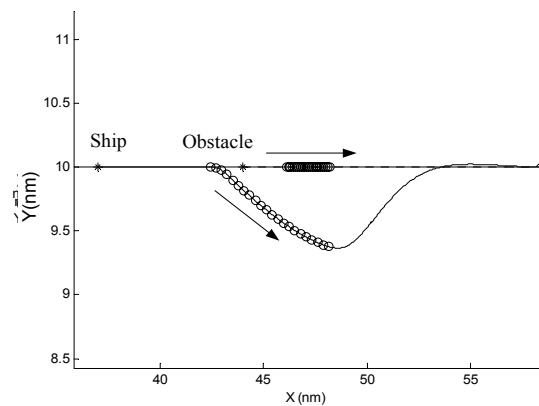

Fig. 30. Passing a moving vehicle.

6. CONCLUDING REMARKS

In this paper, an algorithm for collision avoiding autonomous navigation of marine vehicles is proposed under the COLREGS guidelines. In particular, in view of the advantages and limitations of the so called potential field approach, a modified algorithm, i.e. the MVFF (Modified Virtual Force Field) method is newly devised. The algorithm incorporates two behavior parameters, namely α and β , as well as a mode number S , thus providing a certain level of flexibility in the selection of track-keeping mode. α reflects the desire to approach the next waypoint while β reflects the need to maintain a certain predetermined path. Typical behavior of the ship in the "danger" and "safe" regions is implemented by designing fuzzy logic rules yielding α and β . Furthermore, the concept of mode number S , reflects the operator's selection of return mode, i.e. the degree to which the operator requires the ship to return quickly to its predetermined path. This is critical in situations where the ship may be close to the borders of a neighboring territory, i.e. the so called "danger" region.

It is further demonstrated that either static or moving obstacles can be avoided with the proposed algorithm. In particular, obstacles in stationary state or moving in various directions relative to the given vehicle are simulated in this study. It is detailed that the proposed approach offers a viable means of avoiding catastrophic collisions in these cases by strictly following the COLREGS guidelines.

The complete system involves some two hundred fuzzy rules with four linguistic variables in the premise part, which presents a certain challenge from a computational standpoint. It is conceivable, however, that the rule set can be streamlined and hence reduced in complexity.

REFERENCES

- [1] E. Alfaro-Cid, E. W. McGookin, and D. J. Murray-Smith, "Genetic algorithm optimization of a supply ship propulsion and navigation systems," *OCEANS, 2001: MTS/IEEE Conference and Exhibition*, vol. 4, pp. 2645-2652, 2001.
- [2] R. S. Burns, G. Blackwell, and S. Calvert, "An automatic guidance, navigation and collision avoidance system for ships at sea," *IEE Collo-*

- quium on Control in the Marine Industry, pp. 3/1-3/3, 1988.
- [3] Y. M. Enab, "Intelligent controller design for the ship steering problem," *IEE Proceedings Control theory & Applications*, vol. 143, no. 1, pp. 17-24, 1996.
- [4] T. I. Fossen, *Guidance and Control of Ocean Vehicles*, John Wiley & Sons Ltd., 1994.
- [5] T. Holzhuter, "LQG approach for the high-precision track control of ships," *IEE Proceedings Control theory & Applications*, vol. 144, no. 2, pp. 121-128, 1997.
- [6] X. Hong, C. J. Harris, and P. A. Wilson, "Autonomous ship collision free trajectory navigation and control algorithms," *Proc. 7th IEEE International Conference on Emerging Technologies and Factory Automation, ETFA '99*, vol. 2, pp. 923-929, 1999.
- [7] K.-Y. Im and S.-Y. Oh, "An extended virtual force field based behavioral fusion with neural networks and evolutionary programming for mobile robot navigation," *Proc. of the 2000 Congress on Evolutionary Computation*, vol. 2, pp. 1238-1244, 2000.
- [8] S. B. Lee and I. Kim. "A ship automatic navigation in dynamic environment using artificial intelligence," *Proc. of the Fourth International Conference on Knowledge-Based Intelligent Engineering Systems and Allied Technologies*, vol. 1, pp. 418-422, 2000.
- [9] J. D. Lee and T. F. Sanquist, "Augmenting the operator function model with cognitive operations: assessing the cognitive demands of technological innovation in ship navigation," *IEEE Trans. on Systems, Man and Cybernetics, Part A*, vol. 30, no. 3, pp. 273-285, 2000.
- [10] A. Lozowicki and Z. Zwierzewica, "On Adaptation of H^∞ Control To The Ship Trajectory Tracking Problem," *Proc. of the 3rd IFAC Workshop on Control Applications in Marine Systems*, pp. 131-137, 1995.
- [11] A. A. Masoud and M. M. Bayoumi, "Robot navigation using the vector potential approach," *Proc. of IEEE international Conference on Robotics and Automation*, vol. 1, pp. 805-811, 1993.
- [12] M. Stamenkovich, "An application of artificial neural networks for autonomous ship navigation through a channel," *Position Location and Navigation Symposium, '500 Years After Columbus - Navigation Challenges of Tomorrow'*, *IEEE PLANS '92*, pp. 346-352, 1992.
- [13] T. W. Vaneck, "Fuzzy guidance controller for an autonomous boat," *IEEE Control Systems*, vol. 17, no. 2, pp. 43-51, 1997.
- [14] N. A. J. Witt, R. Sutton, and K. M. Miller, "A track keeping neural network controller for ship guidance," *Proc. of the 3rd IFAC Workshop on Control Applications in Marine Systems*, pp. 385-392, 1995.
- [15] R. J. Zhang, Y. B. Chen, Z. Q. Sun, F. C. Sun, and H. Z. Xu, "Path control of a surface ship in restricted waters using sliding mode," *IEEE Trans. on Control Systems Technology*, vol. 8, no. 4, pp. 722-732, 2000.
- [16] X. K. Zhang, X. L. Jia, and X. C. Wang, "Robust track-keeping autopilot for ships," *Proc. of the 3rd IFAC Workshop on Control Applications in Marine Systems*, pp. 138-142, 1995.



Sang-Min Lee received the M.S. degree in Control and Instrumentation Engineering from Changwon National University, Changwon, Korea, in 1998. He is currently pursuing a Ph.D. His research interests include intelligent computer systems and control, neural networks, soft computing techniques, etc.

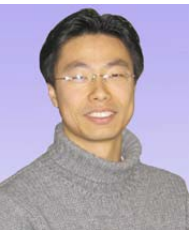

Kyung-Yub Kwon received the M.S. degree in the Department of Control and Instrumentation Engineering from Changwon National University, Changwon, Korea, in 2001. He is currently pursuing a Ph.D. His research interests include intelligent systems, development of DSP-based controllers for servo systems using BLDC motors, etc.



Joongseon Joh (M'95) was born in Hong-Sung, Korea. He received the B.S. degree in Mechanical Engineering from Inha University, Korea, in 1981, the M.S. degree in Mechanical Design and Production Engineering from Seoul National University, Korea, in 1983, and the Ph.D. in Mechanical Engineering from the Georgia Institute of Technology in 1991. From 1983~1986, he was with the central research center of Daewoo Heavy Industries. He was also with the Agency for Defense Development from 1991~1993. Since 1993, he has been with the Department of Control and Instrumentation Engineering, Changwon National University, where he is now a Professor. He received the outstanding paper award from the *Trans. on Fuzzy Systems*, IEEE in 2001. His research interests include intelligent control, development of DSP-based controllers for servo systems using BLDC motors, and the control of electrohydraulic servo systems.