

# The Periodic Moving Average Filter for Removing Motion Artifacts from PPG Signals

Han-Wook Lee, Ju-Won Lee, Won-Geun Jung, and Gun-Ki Lee\*

**Abstract:** The measurement accuracy for heart rate or SpO<sub>2</sub> using photoplethysmography (PPG) is influenced by how well the noise from motion artifacts and other sources can be removed. Eliminating the motion artifacts is particularly difficult since its frequency band overlaps that of the basic PPG signal. Therefore, we propose the Periodic Moving Average Filter (PMAF) to remove motion artifacts. The PMAF is based on the quasi-periodicity of the PPG signals. After segmenting the PPG signal on periodic boundaries, we average the  $m^{\text{th}}$  samples of each period. As a result, we remove the motion artifacts well without the deterioration of the characteristic point.

**Keywords:** Heart rate, motion artifact, moving average, PPG, SpO<sub>2</sub>.

## 1. INTRODUCTION

Photoplethysmography (PPG) was first reported in 1937 [1]. It is a noninvasive, electro-optic method for detecting the cardiovascular pulse wave generated by the elastic nature of the peripheral vascular arteries excited by the quasi-periodic contractions of the heart. Various noises tend to decrease the accuracy of the measured PPG signal, including respiration, motion artifacts, and external light sources. Among them, motion artifacts are the main cause of degraded accuracy [2]. The PPG signal is easy to be exposed to more noise according as the medical instruments decrease in size and become portable or wearable. Especially, the frequency band of the motion artifacts overlaps that of the PPG signal. So it is difficult to remove the motion artifacts from the PPG signal. Removing motion artifacts from PPG signals has been the subject of numerous biomedical research projects.

In this paper, we exploit the quasi-periodicity of the PPG signal to remove the noise without causing deterioration of the original PPG signal characteristics. We call our method the Periodic Moving Average

Filter (PMAF).

## 2. FEATURES OF MOTION ARTIFACTS

PPG is a signal generated by measuring the change in light. It can be used to monitor saturation of peripheral oxygen (SpO<sub>2</sub>), heart rate, and status of the anesthesia [3].

The PPG signal is affected by various noises in the patient's environment, such as the patient's condition, respiration, or movement [4], and each type of noise covers a range of frequencies. For example, the frequency band of respiration is 0.04-1.6 Hz, and the frequency band of the motion artifacts caused by the patient's movement is 0.1Hz and higher. The frequency band of the PPG signal pulse wave is in the range 0.5-4.0 Hz [5,6]. The frequencies of the motion artifacts and the PPG signal thus overlap, making it impractical to separate them using classical filtering methods [7].

The moving average method or adaptive filters are generally used to remove motion artifacts. The moving average method works well for intermittent noise, but cannot remove the motion artifact of large amplitude or one that occurs suddenly. If the order of the moving average filter increases, the PPG signal quality deteriorates. The adaptive filter does work better and does not degrade the PPG signal, but the filter is hard to construct in real time. Because the convergence properties of the adaptive filter are probably deteriorate according to the unsuitable value of the filter's order, coefficients, and convergence constant in noisy environment[8]. Therefore, we propose a new method that not only can remove the motion artifact without degrading the PPG signal but can also be operated in real time stably.

---

Manuscript received May 7, 2007; revised September 14, 2007; accepted October 2, 2007. Recommended by Editorial Board member Sun Kook Yoo under the direction of Editor Jin Young Choi.

Han-Wook Lee, Ju-Won Lee, and Gun-Ki Lee are with the Department of Electronic Engineering, Gyeongsang National University, 900 Gajwa-dong, Jinju-si, Kyungnam 660-701, Korea (e-mails: {hw0318, bioee52}@empal.com, gklee@gnu.ac.kr).

Won-Geun Jung is with the Department of Electronic & Communication, Nam-hae College, 195 Nambyun-ri, Namhae-eub, Namhae-gun, Kyungnam 668-801, Korea (e-mail: twinjj@empal.com).

\*Corresponding author.

### 3. PROPOSED METHOD

#### 3.1. PMAF method

The PPG signal associated with heart pulsation is inherently quasi-periodic [9]. We use that quasi-periodicity in our method. Fig. 1 shows the concept of the proposed PMAF method. After the PPG signal is segmented into periods, each period is resampled with the same number of samples for each. The  $m^{\text{th}}$  samples of each of  $L$  periods are then averaged. The result is that the motion artifacts are removed without degrading the PPG signal. Fig. 2 shows the structure of the proposed PMAF method. The block  $P^{-1}$  indicates one period delay, that is, the previous period.

The input signal with the noise is represented by

$$S_{in}(n) = P(n) + N(n). \quad (1)$$

The input signal  $S_{in}(n)$  is the PPG signal  $P(n)$  with the noise signal  $N(n)$ . For segmenting the signal, it is important to determine the segmentation point. The  $p^{\text{th}}$  segmentation point's value  $D_{S_p}$  is represented by the  $(p-1)^{\text{th}}$  mean point from the maximum and minimum.

$$D_{S_p} = \text{Max}(S_{P-1}) - \frac{1}{2}(\text{Max}(S_{P-1}) - \text{Min}(S_{P-1})) \quad (2)$$

The  $p^{\text{th}}$  segmentation point  $n_{D_p}$  is represented by

$$n_{D_p} = \text{Index}\{S_{in}(n) = D_{S_p}\}, \quad (3)$$

where  $\text{Index}\{\}$  denotes the sample  $n$  for which  $S_{in}(n)$  is equal to  $D_{S_p}$ .

Thus, the input signal  $S_{in}(n)$  is segmented into  $P$  periods as in

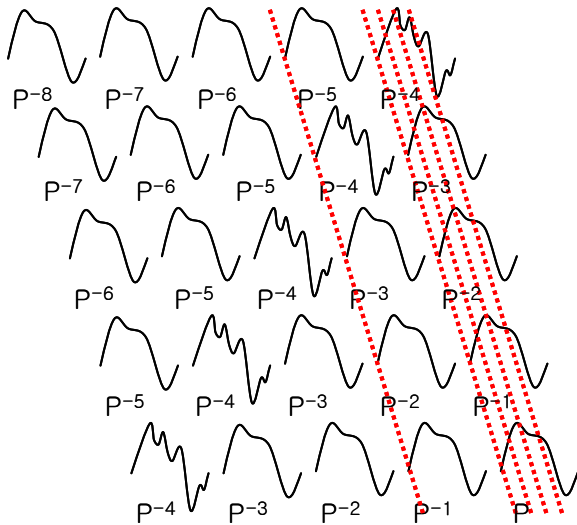

Fig. 1. Concept of the PMAF method.

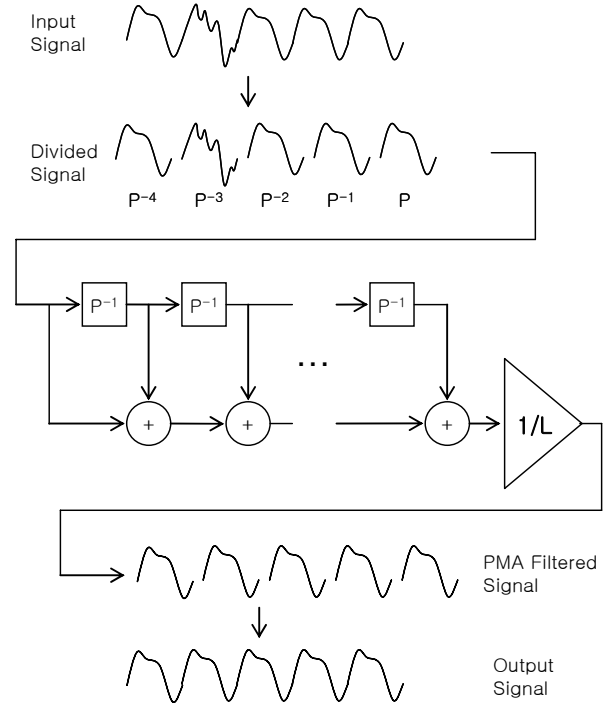

Fig. 2. Structure of the PMAF method.

$$S_{in}(n) = \begin{bmatrix} S_{in}(1), S_{in}(2), \dots, S_{in}(n_{D_1}), \\ S_{in}(n_{D_1} + 1), S_{in}(n_{D_1} + 2), \dots, S_{in}(n_{D_2}), \\ S_{in}(n_{D_2} + 1), S_{in}(n_{D_2} + 2), \dots, S_{in}(n_{D_3}), \\ \dots \\ S_{in}(n_{D_{P-1}} + 1), S_{in}(n_{D_{P-1}} + 2), \dots, S_{in}(n_{D_P}) \end{bmatrix}. \quad (4)$$

The  $p^{\text{th}}$  segmented signal is represented by the series in

$$S_{pin} = \sum_{n=(n_{D_{p-1}}+1)}^{n_{D_p}} S_{in}(n). \quad (5)$$

The number of samples in each period is not equal. So, the interpolation or decimation is done in order to fit the number of the sample each other.

$$S_p(l, m) = S_{pin}(l, \frac{m}{M}), \quad m = 0, \pm M, \pm 2M, \dots, \quad (6)$$

where  $M = \frac{m_{D_p}}{m_{D_{p-1}}}$ .

After this takes place like (6), the  $L$ -period signal  $S_{pin}$  can be reconstructed in the  $L$ -by- $M$  matrix in

order to execute the PMAF.

$$S_p(l, m) = \begin{bmatrix} S(p,1), S(p,2), \dots, S(p,m), \dots, S(p,M) \\ S(p-1,1), S(p-1,2), \dots, S(p-1,m), \dots, S(p-1,M) \\ S(p-2,1), S(p-2,2), \dots, S(p-2,m), \dots, S(p-2,M) \\ \dots \\ S(p-l,1), S(p-l,2), \dots, S(p-l,m), \dots, S(p-l,M) \\ \dots \\ S(p-(L-1),1), S(p-(L-1),2), \dots, S(p-(L-1),m), \dots, S(p-(L-1),M) \end{bmatrix} \quad (7)$$

where  $L$  is the order of the PMAF, and  $M$  is the number of the samples in each period after resampling. Since the number of samples in each period is now the same, the PMAF can be applied. The output signal of the PMAF in each period is represented by

$$S_{p_{out}}(m) = \frac{1}{L} \sum_{l=0}^{L-1} S_p(l, m). \quad (8)$$

When PMA Filtered all  $L$ -periods are joined to each other, the output signal  $S_{out}$  is represented as

$$S_{out}(n) = [S_{1_{out}}(n), S_{2_{out}}(n), \dots, S_{p_{out}}(n)]. \quad (9)$$

### 3.2. PMAF recursive model

The performance of the PMAF degenerates, however, when the noise is periodic. The shivering noise from a chilly patient would be one example, and another refinement is necessary to overcome this drawback.

$$S_p(l, m) = \begin{bmatrix} S(p,1), S(p,2), \dots, S(p,m), \dots, S(p,M) \\ S_{p_{out}}(p-1,1), S_{p_{out}}(p-1,2), \dots, S_{p_{out}}(p-1,M) \\ S_{p_{out}}(p-2,1), S_{p_{out}}(p-2,2), \dots, S_{p_{out}}(p-3,M) \\ \dots \\ S_{p_{out}}(p-l,1), S_{p_{out}}(p-l,2), \dots, S_{p_{out}}(p-l,M) \\ \dots \\ S_{p_{out}}(p-(L-1),1), S_{p_{out}}(p-(L-1),2), \dots, \\ S_{p_{out}}(p-(L-1),M) \end{bmatrix} \quad (10)$$

Equation (10) is the matrix with the recursive input signal. Every input period signal of the PMAF except the present period are all fed back from the previous output signal of the PMAF.

## 4. EXPERIMENTS AND RESULTS

The PMAF was simulated by using MathWorks Matlab. The input signal was the PPG signal with noise, sampled at 500 Hz. After filtering the input signal with a 5-Hz 8th-order Butterworth low-pass filter, we estimated the maximum and minimum value of each period. The means of each period were obtained from the maximum and minimum values applying the zero crossing method. These points of the means determined the boundaries of each period. Because the number of samples in each period was not equal, interpolation or decimation was performed to ensure that each period had the same number of

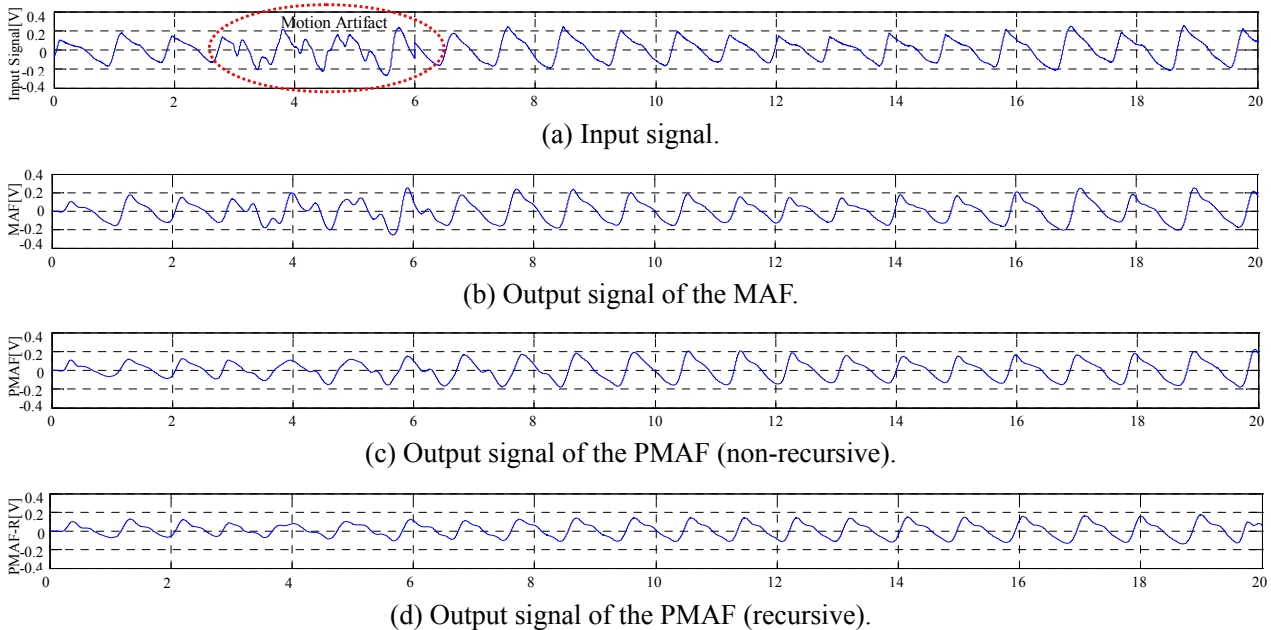

Fig. 3. Input signal and the processing results. Signal with tap noise from a man, age 34.

samples.

We used five periods for the PMAF. Fig. 3 presents the results of the simulation using the input signal with the tap noise. Fig. 3(a) shows the input signal with the motion artifact clearly marked. Fig. 3(b) is the result of a classical 30th-order moving average filter (MAF). Fig. 3(c) shows the result of the PMAF non-recursive model, and Fig. 3(d) gives the result of the PMAF recursive model.

We compared the heart rate variation of the proposed method with that of the classical MAF method (see Table 1). The heart rate variation of the proposed method is lower than that of the classical method. Fig. 4 shows the heart rate variation for those

Table 1. Heart rate variation (tap noise).

Signal	Input signal	MAF	PMAF non-recursive	PMAF recursive
HR (Avg.)	51.23	51.24	54.64	54.64
HR Var. (%)	6.9207 (12.8)	6.144 (11.99)	3.7915 (8.2)	3.3911 (6.2)

four signals. The heart rate during the first period is not affected by the PMAF. The parts marked in dotted circle are influenced by the motion artifact. We can

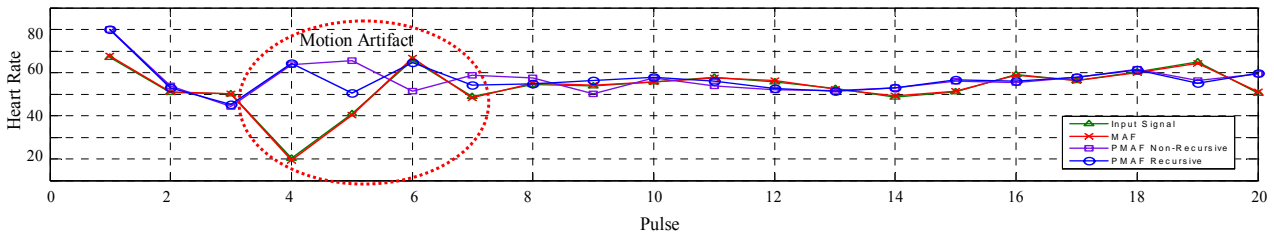

Fig. 4. Heart rate variation comparison of the Fig. 3' results.

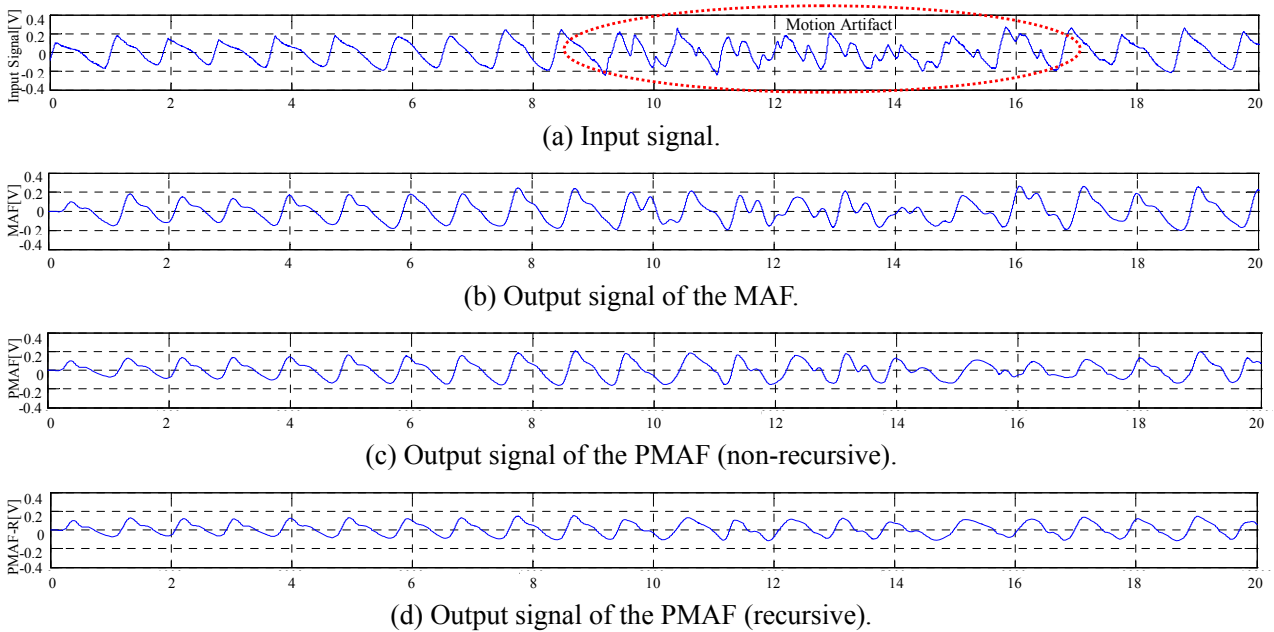

Fig. 5. Input signal and the processing results. Signal with shivering noise from a man, age 34.

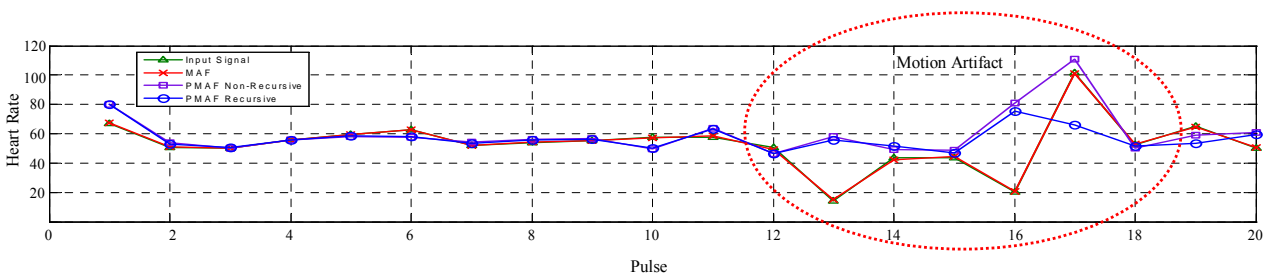
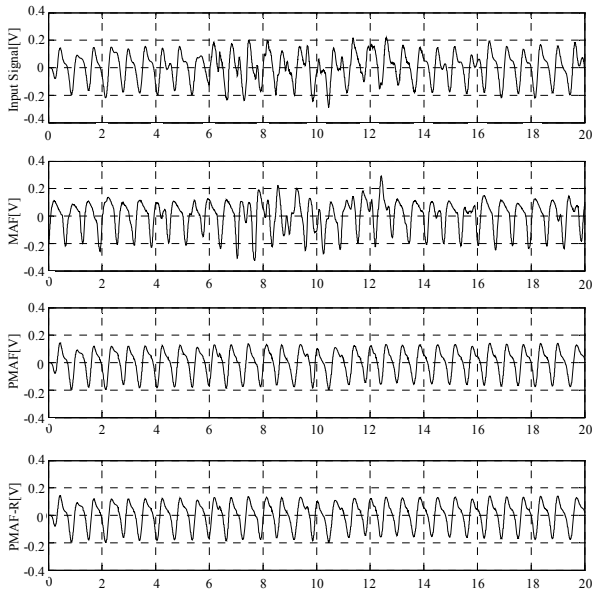
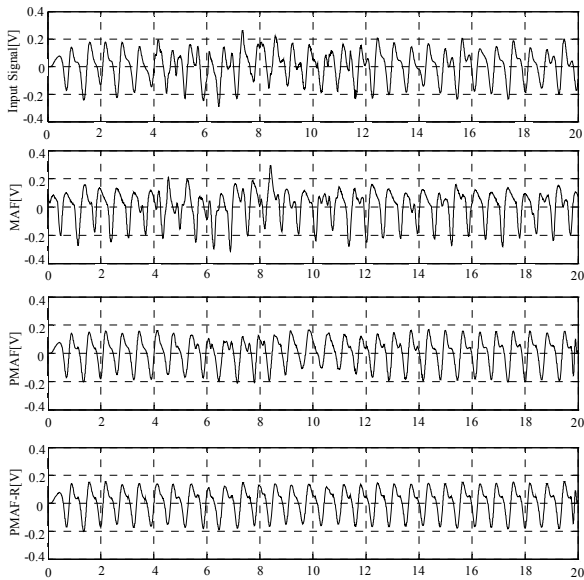

Fig. 6. Heart rate variation comparison of the Fig. 5' results.



(a) Case I: Man, age 52.



(b) Case II: Woman, age 22.

Fig. 7. Input signal and the processing results of several age's groups.

see that the o-line and the □-line (our proposed method) are more stable than the others. Note that the section between 4 and 7s, which contains the motion artifacts, shows that the proposed method exhibits better efficiency than the classical method.

Fig. 5 shows the results of the simulation for the input signal with the shivering noise in the same order as in Fig. 3. For shivering noise, the result of the PMAF non-recursive model is not outstanding. The PMAF recursive model, however, shows good performance for the longer-term noise.

The heart rate variation in the second simulation is shown in Table 2. In this case, the PMAF non-

Table 2. Heart rate variation (shivering noise).

Signal	Input signal	MAF	PMAF non-recursive	PMAF recursive
HR (Avg.)	51.229	54.70	57.48	54.73
HR Var. (%)	9.8716 (12.8)	7.0825 (7.1)	7.5671 (7.1)	4.6255 (4.9)

recursive model performed in a similar manner to the MAF. The recursive model, however, has a heart rate variation 2.2% lower than that of the MAF.

For testing the performance of PMAF, we simulate this algorithm for more people. Fig. 7 shows the results of the simulation for several age's groups.

### 5. CONCLUSIONS

Our PMAF method gave good results in removing motion artifacts without degrading the PPG signal. When the recursive model was applied, the periodic noise could also be removed. Applying these methods to portable medical instruments should improve their performance.

### REFERENCES

- [1] A. B. Hertzman, "Photoelectric plethysmography of the fingers and toes in man," *Proc. Soc. Exp. Biol. Med.*, no. 37, pp. 529-534, 1937.
- [2] B. A. Shapiro, W. T. Peruzzi, and R. Templin, *Clinical Application of Blood Gases, 5th ed.*, vol. 64, Mosby, St. Louis, MO, USA, 1994.
- [3] <http://en.wikipedia.org/wiki/Photoplethysmograph>
- [4] J. Lee, W. Jung, I. Kang, Y. Kim, and G. Lee, "Design of filter to reject motion artifact of pulse oximetry," *Comput. Stand. Interfaces*, vol. 26, no. 3, pp. 241-249. 2004.
- [5] MASIMO, *Discrete Saturation Transform*, Signal Extraction Technology of MASIMO Co., Technical Bulletin 1, 2001.
- [6] J. J. Carr and J. M. Brown, *Introduction to Biomedical Equipment Technology*, Prentice-Hall, Upper Saddle River, NJ, USA, 1998.
- [7] T. L. Rusch, R. Sankar, and J. E. Schharf, "Signal processing methods for pulse oximetry," *Comput. Biol. Med.*, vol. 26, no. 2, pp. 143-159, 1996.
- [8] J.-W. Lee and G.-K. Lee, "Design of an adaptive filter with dynamic structure for ECG signal processing," *International Journal of Control, Automation, and Systems*, vol. 3, no. 1, pp. 137-142, March 2005.
- [9] P. E. McSharry, G. D. Clifford, L. Tarassenko, and L. A. Smith, "A dynamical model for

generating synthetic electrocardiogram signals,” *IEEE Trans. Biomed. Eng.*, vol. 50, no. 3, pp. 289-294, 2003.



**Han-Wook Lee** received the B.S. and M.S. degrees in Electronic Engineering in 1999 and 2001 both from Gyeongsang National University. He is presently a Ph.D. candidate in Electronic Engineering of Gyeongsang National University. His research interests include biomedical signal processing, ubiquitous networks and

human computer interface.



**Ju-Won Lee** received the B.S. degree in Electronic Engineering of Jinju National University in 1997, the M.S. degree in Electronic Communication Engineering of Korea Maritime National University in 1999 and the Ph.D. degree in Electronic Engineering of Gyeongsang National University in 2003. His research interests

include biomedical signal processing, medical measurement system, image processing, artificial intelligence, HCI and related areas.



**Won-Geun Jung** received the B.S. degree in Electronic Engineering of Jinju National University in 1997, the M.S. and Ph.D. degrees in Electronic Engineering of Gyeongsang National University, in 2001 and 2004. He is interested in biomedical signal processing and electronic applications.



**Gun-Ki Lee** received the M.S. degree in Electrical Engineering in 1978, and the Ph.D. degree in Biomedical Engineering in 1990 all from Yonsei University. He is presently a Researcher of ERI (Engineering Research Institute) and Professor of the Department of Electronic Engineering, Gyeongsang National University. His

research interests include biomedical signal processing, telemedicine and ubiquitous networks.